

# Technical Information

## Proline Promass F 300

Coriolis flowmeter



Flowmeter with premium accuracy, robustness and a compact, easily accessible transmitter

### Application

- Measuring principle operates independently of physical fluid properties such as viscosity or density
- Highest measurement performance for liquids and gases under varying, demanding process conditions

### Device properties

- Mass/volume flow: measurement error  $\pm 0.05\%$
- Medium temperature:  $-196$  to  $+350\text{ }^{\circ}\text{C}$  ( $-320$  to  $+662\text{ }^{\circ}\text{F}$ )
- Nominal diameter: DN 8 to 250 ( $\frac{3}{8}$  to 10")
- Compact dual-compartment housing with up to 3 I/Os
- Backlit display with touch control and WLAN access
- Remote display available

### Your benefits

- Highest process safety – immune to fluctuating and harsh environments
- Fewer process measuring points – multivariable measurement (flow, density, temperature)
- Space-saving installation – no in-/outlet run needs
- Full access to process and diagnostic information – numerous, freely combinable I/Os and Ethernet
- Reduced complexity and variety – freely configurable I/O functionality
- Integrated verification – Heartbeat Technology

## Table of contents





<b>About this document</b> .....	<b>4</b>	<b>Environment</b> .....	<b>59</b>
Symbols .....	4	Ambient temperature range .....	59
<b>Function and system design</b> .....	<b>5</b>	Storage temperature .....	59
Measuring principle .....	5	Climate class .....	59
Measuring system .....	7	Relative humidity .....	59
Equipment architecture .....	8	Operating height .....	60
Security .....	8	Degree of protection .....	60
<b>Input</b> .....	<b>11</b>	Vibration- and shock-resistance .....	60
Measured variable .....	11	Interior cleaning .....	60
Measuring range .....	11	Mechanical load .....	60
Operable flow range .....	12	Electromagnetic compatibility (EMC) .....	60
Input signal .....	12	<b>Process</b> .....	<b>60</b>
<b>Output</b> .....	<b>14</b>	Medium temperature range .....	60
Output and input variants .....	14	Density .....	62
Output signal .....	16	Pressure-temperature ratings .....	62
Signal on alarm .....	22	Sensor housing .....	67
Load .....	24	Rupture disk .....	68
Ex connection data .....	24	Flow limit .....	68
Low flow cut off .....	26	Pressure loss .....	68
Galvanic isolation .....	26	System pressure .....	68
Protocol-specific data .....	26	Thermal insulation .....	69
<b>Power supply</b> .....	<b>33</b>	Heating .....	69
Terminal assignment .....	33	Vibrations .....	70
Available device plugs .....	34	<b>Custody transfer</b> .....	<b>71</b>
Supply voltage .....	35	<b>Mechanical construction</b> .....	<b>72</b>
Power consumption .....	35	Dimensions in SI units .....	72
Current consumption .....	35	Dimensions in US units .....	93
Power supply failure .....	35	Weight .....	104
Overcurrent protection element .....	35	Materials .....	105
Electrical connection .....	36	Process connections .....	108
Potential equalization .....	46	Surface roughness .....	108
Terminals .....	46	<b>Operability</b> .....	<b>109</b>
Cable entries .....	46	Operating concept .....	109
Pin assignment, device plug .....	46	Languages .....	109
Cable specification .....	48	Local operation .....	109
Overvoltage protection .....	51	Remote operation .....	110
<b>Performance characteristics</b> .....	<b>51</b>	Service interface .....	116
Reference operating conditions .....	51	Network integration .....	117
Maximum measured error .....	51	Supported operating tools .....	118
Repeatability .....	53	HistoROM data management .....	119
Response time .....	54	<b>Certificates and approvals</b> .....	<b>121</b>
Influence of ambient temperature .....	54	CE mark .....	121
Influence of medium temperature .....	54	UKCA marking .....	121
Influence of medium pressure .....	55	RCM mark .....	121
Design fundamentals .....	55	Ex approval .....	121
<b>Installation</b> .....	<b>56</b>	Hygienic compatibility .....	123
Mounting location .....	56	Pharmaceutical compatibility .....	123
Orientation .....	57	Functional safety .....	123
Inlet and outlet runs .....	58	HART certification .....	123
Special mounting instructions .....	58	FOUNDATION Fieldbus certification .....	123
		Certification PROFIBUS .....	123
		EtherNet/IP certification .....	124

Certification PROFINET . . . . .	124
Certification PROFINET with Ethernet-APL . . . . .	124
Pressure Equipment Directive . . . . .	124
Radio approval . . . . .	124
Measuring instrument approval . . . . .	124
Additional certification . . . . .	125
Other standards and guidelines . . . . .	125
<b>Ordering information . . . . .</b>	<b>126</b>
<b>Application packages . . . . .</b>	<b>126</b>
Diagnostic functionality . . . . .	126
Heartbeat Technology . . . . .	126
Concentration measurement . . . . .	127
Special density . . . . .	127
Petroleum . . . . .	127
Petroleum & locking function . . . . .	127
OPC-UA Server . . . . .	128
<b>Accessories . . . . .</b>	<b>128</b>
Device-specific accessories . . . . .	128
Communication-specific accessories . . . . .	129
Service-specific accessories . . . . .	130
System components . . . . .	130
<b>Documentation . . . . .</b>	<b>131</b>
Standard documentation . . . . .	131
Supplementary device-dependent documentation . . . . .	132
<b>Registered trademarks . . . . .</b>	<b>133</b>





## About this document

### Symbols









#### Electrical symbols

Symbol	Meaning
	Direct current
	Alternating current
	Direct current and alternating current
	<b>Ground connection</b> A grounded terminal which, as far as the operator is concerned, is grounded via a grounding system.
	<b>Potential equalization connection (PE: protective earth)</b> Ground terminals that must be connected to ground prior to establishing any other connections.  The ground terminals are located on the interior and exterior of the device: <ul style="list-style-type: none"> <li>▪ Interior ground terminal: potential equalization is connected to the supply network.</li> <li>▪ Exterior ground terminal: device is connected to the plant grounding system.</li> </ul>

#### Communication-specific symbols



Symbol	Meaning
	<b>Wireless Local Area Network (WLAN)</b> Communication via a wireless, local network.
	<b>LED</b> Light emitting diode is off.
	<b>LED</b> Light emitting diode is on.
	<b>LED</b> Light emitting diode is flashing.

#### Symbols for certain types of information

Symbol	Meaning
	<b>Permitted</b> Procedures, processes or actions that are permitted.
	<b>Preferred</b> Procedures, processes or actions that are preferred.
	<b>Forbidden</b> Procedures, processes or actions that are forbidden.
	<b>Tip</b> Indicates additional information.
	Reference to documentation
	Reference to page
	Reference to graphic
	Visual inspection



Symbols in graphics

Symbol	Meaning
1, 2, 3, ...	Item numbers
1, 2, 3, ...	Series of steps
A, B, C, ...	Views
A-A, B-B, C-C, ...	Sections
	Hazardous area
	Safe area (non-hazardous area)
	Flow direction

Function and system design

Measuring principle

The measuring principle is based on the controlled generation of Coriolis forces. These forces are always present in a system when both translational and rotational movements are superimposed.

$$F_c = 2 \cdot \Delta m (v \cdot \omega)$$

$F_c$  = Coriolis force

$\Delta m$  = moving mass

$\omega$  = rotational velocity

$v$  = radial velocity in rotating or oscillating system

The amplitude of the Coriolis force depends on the moving mass  $\Delta m$ , its velocity  $v$  in the system and thus on the mass flow. Instead of a constant rotational velocity  $\omega$ , the sensor uses oscillation.

In the sensor, two parallel measuring tubes containing flowing fluid oscillate in antiphase, acting like a tuning fork. The Coriolis forces produced at the measuring tubes cause a phase shift in the tube oscillations (see illustration):

- At zero flow (when the fluid is at a standstill) the two tubes oscillate in phase (1).
- Mass flow causes deceleration of the oscillation at the inlet of the tubes (2) and acceleration at the outlet (3).

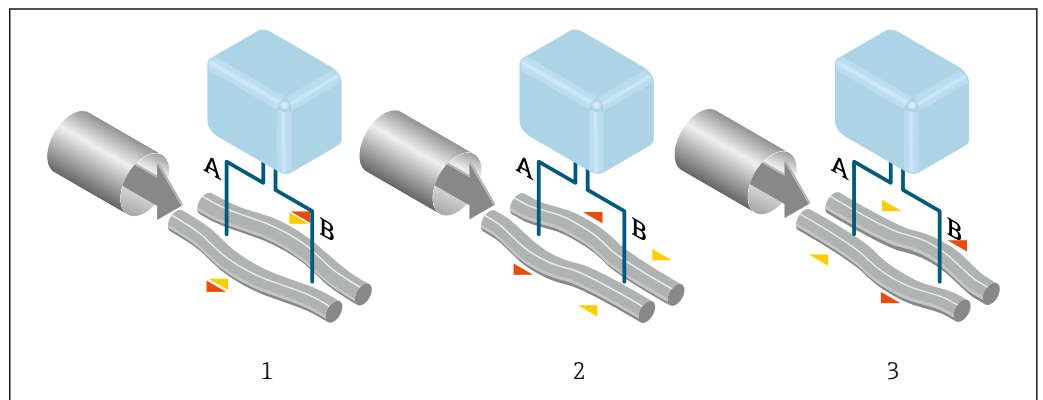

A0028850

The phase difference (A-B) increases with increasing mass flow. Electrodynamics sensors register the tube oscillations at the inlet and outlet. System balance is ensured by the antiphase oscillation of the two measuring tubes. The measuring principle operates independently of temperature, pressure, viscosity, conductivity and flow profile.

**Density measurement**

The measuring tube is continuously excited at its resonance frequency. A change in the mass and thus the density of the oscillating system (comprising measuring tube and fluid) results in a corresponding, automatic adjustment in the oscillation frequency. The resonance frequency is thus a function of the medium density. The microprocessor utilizes this relationship to obtain a density signal.

**Volume measurement**

Together with the measured mass flow, this is used to calculate the volume flow.

**Temperature measurement**

The temperature of the measuring tube is determined in order to calculate the compensation factor due to temperature effects. This signal corresponds to the process temperature and is also available as an output signal.

**Gas Fraction Handler (GFH)**

The Gas Fraction Handler is a Promass software function that improves measurement stability and repeatability. The function continuously checks for the presence of disturbances in single-phase flow, i.e. gas bubbles in liquids or droplets in gas. In the presence of the second phase, flow and density become increasingly unstable. The Gas Fraction Handler function improves measurement stability with respect to the severity of the disturbances, without any effect under single-phase flow conditions.



The Gas Fraction Handler is only available in device versions with HART, Modbus RS485, PROFINET and PROFINET with Ethernet-APL.



For detailed information on the Gas Fraction Handler, see the Special Documentation for "Gas Fraction Handler" →  132

**Measuring system**

The device consists of a transmitter and a sensor.  
 The device is available as a compact version:  
 The transmitter and sensor form a mechanical unit.

**Transmitter**

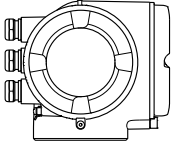
<p><b>Proline 300</b></p>  <p style="text-align: right; font-size: small;">A0026708</p>	<p>Device versions and materials:</p> <ul style="list-style-type: none"> <li>■ Transmitter housing                             <ul style="list-style-type: none"> <li>■ Aluminum, coated: aluminum, AlSi10Mg, coated</li> <li>■ Stainless, hygienic: stainless steel, 1.4404</li> <li>■ Cast, stainless: cast, stainless steel, 1.4409 (CF3M) similar to 316L</li> </ul> </li> <li>■ Material of window in transmitter housing:                             <ul style="list-style-type: none"> <li>■ Aluminum, coated: glass</li> <li>■ Stainless, hygienic: polycarbonate</li> <li>■ Cast, stainless: glass</li> </ul> </li> </ul> <p>Configuration:</p> <ul style="list-style-type: none"> <li>■ External operation via 4-line, illuminated graphic local display (LCD) with touch control and guided menus ("Make-it-run" wizards) for application-specific commissioning.</li> <li>■ Via service interface or WLAN interface:                             <ul style="list-style-type: none"> <li>■ Operating tools (e.g. FieldCare, DeviceCare)</li> <li>■ Web server (access via Web browser, e.g. Microsoft Internet Explorer, Microsoft Edge)</li> </ul> </li> </ul>
--	---

**Sensor**

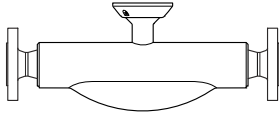
<p><b>Promass F</b></p>  <p style="text-align: right; font-size: small;">A0026713</p>	<ul style="list-style-type: none"> <li>■ Bent dual-tube system</li> <li>■ Excellent performance across a wide range of applications</li> <li>■ Simultaneous measurement of flow, volume flow, density and temperature (multivariable)</li> <li>■ Immune to process influences</li> <li>■ Nominal diameter range: DN 8 to 250 (3/8 to 10")</li> <li>■ Materials:                             <ul style="list-style-type: none"> <li>■ Sensor: stainless steel, 1.4301 (304); optional 1.4404 (316/316L)</li> <li>■ Measuring tubes: stainless steel, 1.4539 (904L); 1.4404 (316/316L); Alloy C22, 2.4602 (UNS N06022)</li> <li>■ Process connections: stainless steel, 1.4404 (316/316L); 1.4301 (304); Alloy C22, 2.4602 (UNS N06022)</li> </ul> </li> </ul>
--	--

## Equipment architecture

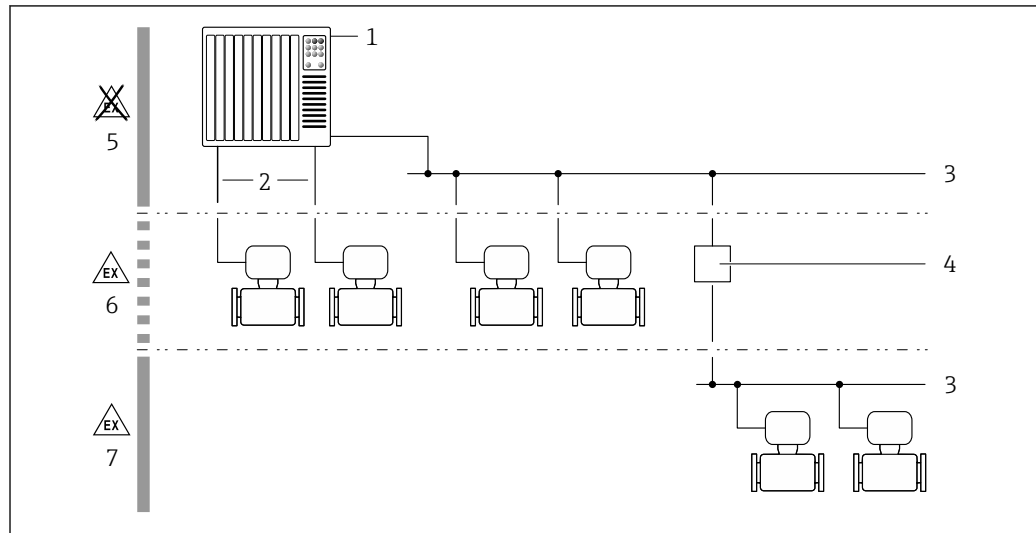

A0027512

1 Possibilities for integrating measuring devices into a system

- 1 Control system (e.g. PLC)
- 2 Connecting cable (0/4 to 20 mA HART etc.)
- 3 Fieldbus
- 4 Coupler
- 5 Non-hazardous area
- 6 Hazardous area: Zone 2; Class I, Division 2
- 7 Hazardous area: Zone 1; Class I, Division 1

## Security

## IT security

Our warranty is valid only if the product is installed and used as described in the Operating Instructions. The product is equipped with security mechanisms to protect it against any inadvertent changes to the settings.

IT security measures, which provide additional protection for the product and associated data transfer, must be implemented by the operators themselves in line with their security standards.

## Device-specific IT security

The device offers a range of specific functions to support protective measures on the operator's side. These functions can be configured by the user and guarantee greater in-operation safety if used correctly. An overview of the most important functions is provided in the following section:

Function/interface	Factory setting	Recommendation
Write protection via hardware write protection switch → 9	Not enabled	On an individual basis following risk assessment
Access code (also applies for Web server login or FieldCare connection) → 9	Not enabled (0000)	Assign a customized access code during commissioning
WLAN (order option in display module)	Enabled	On an individual basis following risk assessment
WLAN security mode	Enabled (WPA2-PSK)	Do not change
WLAN passphrase (password) → 9	Serial number	Assign a customized WLAN passphrase during commissioning
WLAN mode	Access point	On an individual basis following risk assessment
Web server → 9	Enabled	On an individual basis following risk assessment
CDI-RJ45 service interface → 10	-	On an individual basis following risk assessment

#### *Protecting access via hardware write protection*

Write access to the parameters of the device via the local display, Web browser or operating tool (e.g. FieldCare, DeviceCare) can be disabled via a write protection switch (DIP switch on the main electronics module). When hardware write protection is enabled, only read access to the parameters is possible.

Hardware write protection is disabled when the device is delivered.

#### *Protecting access via a password*

Different passwords are available to protect write access to the device parameters or access to the device via the WLAN interface.

- **User-specific access code**  
Protect write access to the device parameters via the local display, Web browser or operating tool (e.g. FieldCare, DeviceCare). Access authorization is clearly regulated through the use of a user-specific access code.
- **WLAN passphrase**  
The network key protects a connection between an operating unit (e.g. notebook or tablet) and the device via the WLAN interface which can be ordered as an option.
- **Infrastructure mode**  
When the device is operated in infrastructure mode, the WLAN passphrase corresponds to the WLAN passphrase configured on the operator side.

#### *User-specific access code*

Write access to the device parameters via the local display, Web browser or operating tool (e.g. FieldCare, DeviceCare) can be protected by the modifiable, user-specific access code.

#### *WLAN passphrase: Operation as WLAN access point*

A connection between an operating unit (e.g. notebook or tablet) and the device via the WLAN interface, which can be ordered as an optional extra, is protected by the network key. The WLAN authentication of the network key complies with the IEEE 802.11 standard.

When the device is delivered, the network key is pre-defined depending on the device. It can be changed via the **WLAN settings** submenu in the **WLAN passphrase** parameter.

#### *Infrastructure mode*

A connection between the device and WLAN access point is protected by means of an SSID and passphrase on the system side. Please contact the relevant system administrator for access.

#### *General notes on the use of passwords*

- The access code and network key supplied with the device should be changed during commissioning.
- Follow the general rules for generating a secure password when defining and managing the access code or network key.
- The user is responsible for the management and careful handling of the access code and network key.

#### *Access via Web server*

The device can be operated and configured via a Web browser with the integrated Web server. The connection is via the service interface (CDI-RJ45) or the WLAN interface. For device versions with the EtherNet/IP and PROFINET communication protocols, the connection can also be established via the terminal connection for signal transmission with EtherNet/IP, PROFINET (RJ45 plug) or PROFINET with Ethernet-APL (two-wire).



The Web server is enabled when the device is delivered. The Web server can be disabled if necessary (e.g. after commissioning) via the **Web server functionality** parameter.

The device and status information can be hidden on the login page. This prevents unauthorized access to the information.



For detailed information on device parameters, see:  
The "Description of Device Parameters" document → 131

#### Access via OPC-UA

 The "OPC UA Server" application package is available in the device version with the HART communication protocol →  128.

The device can communicate with OPC UA clients using the "OPC UA Server" application package.

The OPC UA server integrated in the device can be accessed via the WLAN access point using the WLAN interface - which can be ordered as an optional extra - or the service interface (CDI- RJ45) via Ethernet network. Access rights and authorization as per separate configuration.

The following Security Modes are supported as per the OPC UA Specification (IEC 62541):

- None
- Basic128Rsa15 – signed
- Basic128Rsa15 – signed and encrypted

#### Access via service interface (CDI-RJ45)

The device can be connected to a network via the service interface (CDI-RJ45). Device-specific functions guarantee the secure operation of the device in a network.

The use of relevant industrial standards and guidelines that have been defined by national and international safety committees, such as IEC/ISA62443 or the IEEE, is recommended. This includes organizational security measures such as the assignment of access authorization as well as technical measures such as network segmentation.

 Transmitters with an Ex de approval may not be connected via the service interface (CDI-RJ45)!  
Order code for "Approval transmitter + sensor", options (Ex de): BA, BB, C1, C2, GA, GB, MA, MB, NA, NB

 The device can be incorporated into a ring topology. The device is integrated via the terminal connection for signal transmission (output 1) and the connection to the service interface (CDI-RJ45) .

# Input

**Measured variable**

**Direct measured variables**

- Mass flow
- Density
- Temperature

**Calculated measured variables**

- Volume flow
- Corrected volume flow
- Reference density

**Measuring range**

**Measuring range for liquids**

DN		Measuring range full scale values $\dot{m}_{\min(F)}$ to $\dot{m}_{\max(F)}$	
[mm]	[in]	[kg/h]	[lb/min]
8	$\frac{3}{8}$	0 to 2 000	0 to 73.50
15	$\frac{1}{2}$	0 to 6 500	0 to 238.9
25	1	0 to 18 000	0 to 661.5
40	$1\frac{1}{2}$	0 to 45 000	0 to 1 654
50	2	0 to 70 000	0 to 2 573
80	3	0 to 180 000	0 to 6 615
100	4	0 to 350 000	0 to 12 860
150	6	0 to 800 000	0 to 29 400
250	10	0 to 2 200 000	0 to 80 850

**Measuring range for gases**



The full scale value depends on the density and the sound velocity of the gas used. The full scale value can be calculated with the following formulas:

$$\dot{m}_{\max(G)} = \text{minimum of } (\dot{m}_{\max(F)} \cdot \rho_G : x) \text{ and } (\rho_G \cdot (c_G/2) \cdot d_i^2 \cdot (\pi/4) \cdot 3600 \cdot n)$$

$\dot{m}_{\max(G)}$	Maximum full scale value for gas [kg/h]
$\dot{m}_{\max(F)}$	Maximum full scale value for liquid [kg/h]
$\dot{m}_{\max(G)} < \dot{m}_{\max(F)}$	$\dot{m}_{\max(G)}$ can never be greater than $\dot{m}_{\max(F)}$
$\rho_G$	Gas density in [kg/m <sup>3</sup> ] at operating conditions
x	Limitation constant for max. gas flow [kg/m <sup>3</sup> ]
$c_G$	Sound velocity (gas) [m/s]
$d_i$	Measuring tube internal diameter [m]
$\pi$	Pi
n = 2	Number of measuring tubes

DN		x
[mm]	[in]	[kg/m <sup>3</sup> ]
8	$\frac{3}{8}$	60
15	$\frac{1}{2}$	80



DN		x
[mm]	[in]	[kg/m <sup>3</sup> ]
25	1	90
40	1½	90
50	2	90
80	3	110
100	4	130
150	6	200
250	10	200

 To calculate the measuring range, use the *Applicator* sizing tool →  130

If calculating the full scale value using the two formulas:

1. Calculate the full scale value with both formulas.
2. The smaller value is the value that must be used.

#### Recommended measuring range

 Flow limit →  68

#### Operable flow range

Over 1000 : 1.

Flow rates above the preset full scale value do not override the electronics unit, with the result that the totalizer values are registered correctly.

#### Input signal

#### Output and input variants

→  14

#### External measured values

To increase the accuracy of certain measured variables or to calculate the corrected volume flow for gases, the automation system can continuously write different measured values to the measuring device:

- Operating pressure to increase accuracy (Endress+Hauser recommends the use of a pressure measuring device for absolute pressure, e.g. Cerabar M or Cerabar S)
- Medium temperature to increase accuracy (e.g. iTEMP)
- Reference density for calculating the corrected volume flow for gases

 Various pressure and temperature measuring devices can be ordered from Endress+Hauser: see "Accessories" section →  130

It is recommended to read in external measured values to calculate the corrected volume flow.

#### HART protocol

The measured values are written from the automation system to the measuring device via the HART protocol. The pressure transmitter must support the following protocol-specific functions:

- HART protocol
- Burst mode

#### Current input

The measured values are written from the automation system to the measuring device via the current input →  13.

#### Digital communication

The measured values can be written by the automation system via:

- FOUNDATION Fieldbus
- PROFIBUS DP
- PROFIBUS PA



- Modbus RS485
- EtherNet/IP
- PROFINET
- PROFINET with Ethernet-APL

**Current input 0/4 to 20 mA**

<b>Current input</b>	0/4 to 20 mA (active/passive)
<b>Current span</b>	<ul style="list-style-type: none"> <li>■ 4 to 20 mA (active)</li> <li>■ 0/4 to 20 mA (passive)</li> </ul>
<b>Resolution</b>	1 $\mu$ A
<b>Voltage drop</b>	Typically: 0.6 to 2 V for 3.6 to 22 mA (passive)
<b>Maximum input voltage</b>	$\leq$ 30 V (passive)
<b>Open-circuit voltage</b>	$\leq$ 28.8 V (active)
<b>Possible input variables</b>	<ul style="list-style-type: none"> <li>■ Pressure</li> <li>■ Temperature</li> <li>■ Density</li> </ul>

**Status input**

<b>Maximum input values</b>	<ul style="list-style-type: none"> <li>■ DC -3 to 30 V</li> <li>■ If status input is active (ON): <math>R_i &gt; 3</math> k<math>\Omega</math></li> </ul>
<b>Response time</b>	Configurable: 5 to 200 ms
<b>Input signal level</b>	<ul style="list-style-type: none"> <li>■ Low signal: DC -3 to +5 V</li> <li>■ High signal: DC 12 to 30 V</li> </ul>
<b>Assignable functions</b>	<ul style="list-style-type: none"> <li>■ Off</li> <li>■ Reset the individual totalizers separately</li> <li>■ Reset all totalizers</li> <li>■ Flow override</li> </ul>

## Output

### Output and input variants

Depending on the option selected for output/input 1, different options are available for the other outputs and inputs. Only one option can be selected for each output/input 1 to 3. The following tables must be read vertically (↓).

Example: If the option BA "4–20 mA HART" was selected for output/input 1, one of the options A, B, D, E, F, H, I or J is available for output 2 and one of the options A, B, D, E, F, H, I or J is available for output 3.

### Output/input 1 and options for output/input 2



 Options for output/input 3 →  15

Order code for "Output; input 1" (020) →	Possible options												
Current output 4 to 20 mA HART	BA												
Current output 4 to 20 mA HART Ex i passive	↓	CA											
Current output 4 to 20 mA HART Ex i active		↓	CC										
FOUNDATION Fieldbus			↓	SA									
FOUNDATION Fieldbus Ex i				↓	TA								
PROFIBUS DP					↓	LA							
PROFIBUS PA						↓	GA						
PROFIBUS PA Ex i							↓	HA					
Modbus RS485								↓	MA				
EtherNet/IP 2-port switch integrated									↓	NA			
PROFINET 2-port switch integrated										↓	RA		
PROFINET with Ethernet-APL											↓	RB	
PROFINET with Ethernet-APL Ex i												↓	RC
<b>Order code for "Output; input 2" (021) →</b>	↓	↓	↓	↓	↓	↓	↓	↓	↓	↓	↓	↓	↓
Not assigned	A	A	A	A	A	A	A	A	A	A	A	A	A
Current output 4 to 20 mA	B			B		B	B		B	B	B	B	
Current output 4 to 20 mA Ex i passive		C	C		C			C					C
User-configurable input/output <sup>1)</sup>	D			D		D	D		D	D	D	D	
Pulse/frequency/switch output	E			E		E	E		E	E	E	E	
Double pulse output <sup>2)</sup>	F								F				
Pulse/frequency/switch output Ex i passive		G	G		G			G					G
Relay output	H			H		H	H		H	H	H	H	
Current input 0/4 to 20 mA	I			I		I	I		I	I	I	I	
Status input	J			J		J	J		J	J	J	J	

1) A specific input or output can be assigned to a user-configurable input/output →  21.

2) If double pulse output (F) is selected for output/input 2 (021), only the double pulse output (F) option is available for selection for output/input 3 (022).

Output/input 1 and options for output/input 3

 Options for output/input 2 →  14

Order code for "Output; input 1" (020) →	Possible options												
Current output 4 to 20 mA HART	BA												
Current output 4 to 20 mA HART Ex i passive	↓	CA											
Current output 4 to 20 mA HART Ex i active		↓	CC										
FOUNDATION Fieldbus			↓	SA									
FOUNDATION Fieldbus Ex i				↓	TA								
PROFIBUS DP					↓	LA							
PROFIBUS PA						↓	GA						
PROFIBUS PA Ex i							↓	HA					
Modbus RS485								↓	MA				
EtherNet/IP 2-port switch integrated									↓	NA			
PROFINET 2-port switch integrated										↓	RA		
PROFINET with Ethernet-APL											↓	RB	
PROFINET with Ethernet-APL Ex i												↓	RC
<b>Order code for "Output; input 3" (022) →</b>	↓	↓	↓	↓	↓	↓	↓	↓	↓	↓	↓	↓	↓
Not assigned	A	A	A	A	A	A	A	A	A	A	A	A	A
Current output 4 to 20 mA	B						B			B	B	B	B
Current output 4 to 20 mA Ex i passive		C	C										
User-configurable input/output	D						D			D	D	D	D
Pulse/frequency/switch output	E						E			E	E	E	E
Double pulse output (slave) <sup>1)</sup>	F									F			
Pulse/frequency/switch output Ex i passive		G	G										
Relay output	H						H			H	H	H	H
Current input 0/4 to 20 mA	I						I			I	I	I	I
Status input	J						J			J	J	J	J

1) If double pulse output (F) is selected for output/input 2 (021), only the double pulse output (F) option is available for output/input 3 (022).

## Output signal

## Current output 4 to 20 mA HART

Order code	"Output; input 1" (20): Option BA: current output 4 to 20 mA HART
Signal mode	Can be set to: <ul style="list-style-type: none"> <li>■ Active</li> <li>■ Passive</li> </ul>
Current range	Can be set to: <ul style="list-style-type: none"> <li>■ 4 to 20 mA NAMUR</li> <li>■ 4 to 20 mA US</li> <li>■ 4 to 20 mA</li> <li>■ 0 to 20 mA (only if the signal mode is active)</li> <li>■ Fixed current</li> </ul>
Open-circuit voltage	DC 28.8 V (active)
Maximum input voltage	DC 30 V (passive)
Load	250 to 700 $\Omega$
Resolution	0.38 $\mu$ A
Damping	Configurable: 0 to 999.9 s
Assignable measured variables	<ul style="list-style-type: none"> <li>■ Mass flow</li> <li>■ Volume flow</li> <li>■ Corrected volume flow</li> <li>■ Density</li> <li>■ Reference density</li> <li>■ Temperature</li> <li>■ Electronics temperature</li> <li>■ Oscillation frequency 0</li> <li>■ Oscillation damping 0</li> <li>■ Signal asymmetry</li> <li>■ Exciter current 0</li> </ul> <p> The range of options increases if the measuring device has one or more application packages.</p>

## Current output 4 to 20 mA HART Ex i

Order code	"Output; input 1" (20) choose from: <ul style="list-style-type: none"> <li>■ Option CA: current output 4 to 20 mA HART Ex i passive</li> <li>■ Option CC: current output 4 to 20 mA HART Ex i active</li> </ul>
Signal mode	Depends on the selected order version.
Current range	Can be set to: <ul style="list-style-type: none"> <li>■ 4 to 20 mA NAMUR</li> <li>■ 4 to 20 mA US</li> <li>■ 4 to 20 mA</li> <li>■ 0 to 20 mA (only if the signal mode is active)</li> <li>■ Fixed current</li> </ul>
Open-circuit voltage	DC 21.8 V (active)
Maximum input voltage	DC 30 V (passive)
Load	<ul style="list-style-type: none"> <li>■ 250 to 400 <math>\Omega</math> (active)</li> <li>■ 250 to 700 <math>\Omega</math> (passive)</li> </ul>
Resolution	0.38 $\mu$ A

<b>Damping</b>	Configurable: 0 to 999.9 s
<b>Assignable measured variables</b>	<ul style="list-style-type: none"> <li>▪ Mass flow</li> <li>▪ Volume flow</li> <li>▪ Corrected volume flow</li> <li>▪ Density</li> <li>▪ Reference density</li> <li>▪ Temperature</li> <li>▪ Electronics temperature</li> <li>▪ Oscillation frequency 0</li> <li>▪ Oscillation damping 0</li> <li>▪ Signal asymmetry</li> <li>▪ Exciter current 0</li> </ul> <p> The range of options increases if the measuring device has one or more application packages.</p>

**FOUNDATION Fieldbus**

<b>FOUNDATION Fieldbus</b>	H1, IEC 61158-2, galvanically isolated
<b>Data transfer</b>	31.25 kbit/s
<b>Current consumption</b>	10 mA
<b>Permitted supply voltage</b>	9 to 32 V
<b>Bus connection</b>	With integrated reverse polarity protection

**PROFIBUS DP**

<b>Signal encoding</b>	NRZ code
<b>Data transfer</b>	9.6 kBaud...12 MBaud
<b>Terminating resistor</b>	Integrated, can be activated via DIP switches

**PROFIBUS PA**

<b>PROFIBUS PA</b>	In accordance with EN 50170 Volume 2, IEC 61158-2 (MBP), galvanically isolated
<b>Data transmission</b>	31.25 kbit/s
<b>Current consumption</b>	10 mA
<b>Permitted supply voltage</b>	9 to 32 V
<b>Bus connection</b>	With integrated reverse polarity protection

**Modbus RS485**

<b>Physical interface</b>	RS485 in accordance with EIA/TIA-485 standard
<b>Terminating resistor</b>	Integrated, can be activated via DIP switches

**EtherNet/IP**

<b>Standards</b>	In accordance with IEEE 802.3
------------------	-------------------------------

**PROFINET**

<b>Standards</b>	In accordance with IEEE 802.3
------------------	-------------------------------

**PROFINET with Ethernet-APL**

<b>Device use</b>	<p><b>Device connection to an APL field switch</b> The device may only be operated according to the following APL port classifications:</p> <ul style="list-style-type: none"> <li>▪ If used in hazardous areas: SLAA or SLAC <sup>1)</sup></li> <li>▪ If used in non-hazardous areas: SLAX</li> </ul> <p>Connection values of APL field switch (corresponds to APL port classification SPCC or SPAA, for instance):</p> <ul style="list-style-type: none"> <li>▪ Maximum input voltage: 15 V<sub>DC</sub></li> <li>▪ Minimum output values: 0.54 W</li> </ul> <p><b>Device connection to an SPE switch</b> The device may only be operated according to the following PoDL power class: If used in the non-hazardous area: PoDL power class 10</p> <p>Connection values of SPE switch (corresponds to PoDL power class 10, 11 or 12):</p> <ul style="list-style-type: none"> <li>▪ Maximum input voltage: 30 V<sub>DC</sub></li> <li>▪ Minimum output values: 1.85 W</li> </ul>
<b>PROFINET</b>	According to IEC 61158 and IEC 61784
<b>Ethernet-APL</b>	According to IEEE 802.3cg, APL port profile specification v1.0, galvanically isolated
<b>Data transfer</b>	10 Mbit/s
<b>Current consumption</b>	<p><b>Transmitter</b></p> <ul style="list-style-type: none"> <li>▪ Max. 400 mA (24 V)</li> <li>▪ Max. 200 mA (110 V, 50/60 Hz; 230 V, 50/60 Hz)</li> </ul>
<b>Permitted supply voltage</b>	9 to 30 V
<b>Network connection</b>	With integrated reverse polarity protection

1) For more information on using the device in the hazardous area, see the Ex-specific Safety Instructions

**Current output 4 to 20 mA**

<b>Order code</b>	"Output; input 2" (21), "Output; input 3" (022): Option B: current output 4 to 20 mA
<b>Signal mode</b>	Can be set to: <ul style="list-style-type: none"> <li>▪ Active</li> <li>▪ Passive</li> </ul>
<b>Current span</b>	Can be set to: <ul style="list-style-type: none"> <li>▪ 4 to 20 mA NAMUR</li> <li>▪ 4 to 20 mA US</li> <li>▪ 4 to 20 mA</li> <li>▪ 0 to 20 mA (only if the signal mode is active)</li> <li>▪ Fixed current</li> </ul>
<b>Maximum output values</b>	22.5 mA
<b>Open-circuit voltage</b>	DC 28.8 V (active)
<b>Maximum input voltage</b>	DC 30 V (passive)
<b>Load</b>	0 to 700 Ω
<b>Resolution</b>	0.38 μA



<b>Damping</b>	Configurable: 0 to 999.9 s
<b>Assignable measured variables</b>	<ul style="list-style-type: none"> <li>▪ Mass flow</li> <li>▪ Volume flow</li> <li>▪ Corrected volume flow</li> <li>▪ Density</li> <li>▪ Reference density</li> <li>▪ Temperature</li> <li>▪ Electronics temperature</li> <li>▪ Oscillation frequency 0</li> <li>▪ Oscillation damping 0</li> <li>▪ Signal asymmetry</li> <li>▪ Exciter current 0</li> </ul> <p> The range of options increases if the measuring device has one or more application packages.</p>

**Current output 4 to 20 mA Ex i passive**

<b>Order code</b>	"Output; input 2" (21), "Output; input 3" (022): Option C: current output 4 to 20 mA Ex i passive
<b>Signal mode</b>	Passive
<b>Current span</b>	Can be set to: <ul style="list-style-type: none"> <li>▪ 4 to 20 mA NAMUR</li> <li>▪ 4 to 20 mA US</li> <li>▪ 4 to 20 mA</li> <li>▪ Fixed current</li> </ul>
<b>Maximum output values</b>	22.5 mA
<b>Maximum input voltage</b>	DC 30 V
<b>Load</b>	0 to 700 Ω
<b>Resolution</b>	0.38 µA
<b>Damping</b>	Configurable: 0 to 999 s
<b>Assignable measured variables</b>	<ul style="list-style-type: none"> <li>▪ Mass flow</li> <li>▪ Volume flow</li> <li>▪ Corrected volume flow</li> <li>▪ Density</li> <li>▪ Reference density</li> <li>▪ Temperature</li> <li>▪ Electronics temperature</li> <li>▪ Oscillation frequency 0</li> <li>▪ Oscillation damping 0</li> <li>▪ Signal asymmetry</li> <li>▪ Exciter current 0</li> </ul> <p> The range of options increases if the measuring device has one or more application packages.</p>

**Pulse/frequency/switch output**

<b>Function</b>	Can be configured as pulse, frequency or switch output
<b>Version</b>	Open collector Can be set to: <ul style="list-style-type: none"> <li>▪ Active</li> <li>▪ Passive</li> <li>▪ Passive NAMUR</li> </ul> <p> Ex-i, passive</p>
<b>Maximum input values</b>	DC 30 V, 250 mA (passive)
<b>Open-circuit voltage</b>	DC 28.8 V (active)
<b>Voltage drop</b>	For 22.5 mA: ≤ DC 2 V

Pulse output	
Maximum input values	DC 30 V, 250 mA (passive)
Maximum output current	22.5 mA (active)
Open-circuit voltage	DC 28.8 V (active)
Pulse width	Configurable: 0.05 to 2 000 ms
Maximum pulse rate	10 000 Impulse/s
Pulse value	Configurable
Assignable measured variables	<ul style="list-style-type: none"> <li>▪ Mass flow</li> <li>▪ Volume flow</li> <li>▪ Corrected volume flow</li> </ul>
Frequency output	
Maximum input values	DC 30 V, 250 mA (passive)
Maximum output current	22.5 mA (active)
Open-circuit voltage	DC 28.8 V (active)
Output frequency	Configurable: end value frequency 2 to 10 000 Hz ( $f_{\max} = 12\,500$ Hz)
Damping	Configurable: 0 to 999.9 s
Pulse/pause ratio	1:1
Assignable measured variables	<ul style="list-style-type: none"> <li>▪ Mass flow</li> <li>▪ Volume flow</li> <li>▪ Corrected volume flow</li> <li>▪ Density</li> <li>▪ Reference density</li> <li>▪ Temperature</li> <li>▪ Electronics temperature</li> <li>▪ Oscillation frequency 0</li> <li>▪ Oscillation damping 0</li> <li>▪ Signal asymmetry</li> <li>▪ Exciter current 0</li> </ul> <p> The range of options increases if the measuring device has one or more application packages.</p>
Switch output	
Maximum input values	DC 30 V, 250 mA (passive)
Open-circuit voltage	DC 28.8 V (active)
Switching behavior	Binary, conductive or non-conductive
Switching delay	Configurable: 0 to 100 s
Number of switching cycles	Unlimited
Assignable functions	<ul style="list-style-type: none"> <li>▪ Off</li> <li>▪ On</li> <li>▪ Diagnostic behavior</li> <li>▪ Limit value <ul style="list-style-type: none"> <li>▪ Mass flow</li> <li>▪ Volume flow</li> <li>▪ Corrected volume flow</li> <li>▪ Density</li> <li>▪ Reference density</li> <li>▪ Temperature</li> <li>▪ Totalizer 1-3</li> </ul> </li> <li>▪ Flow direction monitoring</li> <li>▪ Status <ul style="list-style-type: none"> <li>▪ Partially filled pipe detection</li> <li>▪ Low flow cut off</li> </ul> </li> </ul> <p> The range of options increases if the measuring device has one or more application packages.</p>



**Double pulse output**

<b>Function</b>	Double pulse
<b>Version</b>	Open collector Can be set to: <ul style="list-style-type: none"> <li>▪ Active</li> <li>▪ Passive</li> <li>▪ Passive NAMUR</li> </ul>
<b>Maximum input values</b>	DC 30 V, 250 mA (passive)
<b>Open-circuit voltage</b>	DC 28.8 V (active)
<b>Voltage drop</b>	For 22.5 mA: ≤ DC 2 V
<b>Output frequency</b>	Configurable: 0 to 1000 Hz
<b>Damping</b>	Configurable: 0 to 999 s
<b>Pulse/pause ratio</b>	1:1
<b>Assignable measured variables</b>	<ul style="list-style-type: none"> <li>▪ Mass flow</li> <li>▪ Volume flow</li> <li>▪ Corrected volume flow</li> <li>▪ Density</li> <li>▪ Reference density</li> <li>▪ Temperature</li> </ul> <p> The range of options increases if the measuring device has one or more application packages.</p>

**Relay output**

<b>Function</b>	Switch output
<b>Version</b>	Relay output, galvanically isolated
<b>Switching behavior</b>	Can be set to: <ul style="list-style-type: none"> <li>▪ NO (normally open), factory setting</li> <li>▪ NC (normally closed)</li> </ul>
<b>Maximum switching capacity (passive)</b>	<ul style="list-style-type: none"> <li>▪ DC 30 V, 0.1 A</li> <li>▪ AC 30 V, 0.5 A</li> </ul>
<b>Assignable functions</b>	<ul style="list-style-type: none"> <li>▪ Off</li> <li>▪ On</li> <li>▪ Diagnostic behavior</li> <li>▪ Limit value <ul style="list-style-type: none"> <li>▪ Mass flow</li> <li>▪ Volume flow</li> <li>▪ Corrected volume flow</li> <li>▪ Density</li> <li>▪ Reference density</li> <li>▪ Temperature</li> </ul> </li> <li>▪ Totalizer 1-3</li> <li>▪ Flow direction monitoring</li> <li>▪ Status <ul style="list-style-type: none"> <li>▪ Partially filled pipe detection</li> <li>▪ Low flow cut off</li> </ul> </li> </ul> <p> The range of options increases if the measuring device has one or more application packages.</p>

**User-configurable input/output**

**One** specific input or output is assigned to a user-configurable input/output (configurable I/O) during device commissioning.

The following inputs and outputs are available for assignment:

- Choice of current output: 4 to 20 mA (active), 0/4 to 20 mA (passive)
- Pulse/frequency/switch output
- Choice of current input: 4 to 20 mA (active), 0/4 to 20 mA (passive)
- Status input

The technical values correspond to those of the inputs and outputs described in this section.

## Signal on alarm

Depending on the interface, failure information is displayed as follows:

### HART current output

Device diagnostics	Device condition can be read out via HART Command 48
--------------------	--

### PROFIBUS PA

Status and alarm messages	Diagnostics in accordance with PROFIBUS PA Profile 3.02
Failure current FDE (Fault Disconnection Electronic)	0 mA

### PROFIBUS DP

Status and alarm messages	Diagnostics in accordance with PROFIBUS PA Profile 3.02
---------------------------	---

### EtherNet/IP

Device diagnostics	Device condition can be read out in Input Assembly
--------------------	--

### PROFINET

Device diagnostics	According to "Application Layer protocol for decentralized periphery", Version 2.3
--------------------	--

### PROFINET with Ethernet-APL

Device diagnostics	Diagnostics according to PROFINET PA Profile 4
--------------------	--

### FOUNDATION Fieldbus

Status and alarm messages	Diagnostics in accordance with FF-891
Failure current FDE (Fault Disconnection Electronic)	0 mA

### Modbus RS485

Failure mode	Choose from: <ul style="list-style-type: none"> <li>■ NaN value instead of current value</li> <li>■ Last valid value</li> </ul>
--------------	---

**Current output 0/4 to 20 mA**

*4 to 20 mA*

<b>Failure mode</b>	Choose from: <ul style="list-style-type: none"> <li>▪ 4 to 20 mA in accordance with NAMUR recommendation NE 43</li> <li>▪ 4 to 20 mA in accordance with US</li> <li>▪ Min. value: 3.59 mA</li> <li>▪ Max. value: 22.5 mA</li> <li>▪ Freely definable value between: 3.59 to 22.5 mA</li> <li>▪ Actual value</li> <li>▪ Last valid value</li> </ul>
---------------------	--

*0 to 20 mA*

<b>Failure mode</b>	Choose from: <ul style="list-style-type: none"> <li>▪ Maximum alarm: 22 mA</li> <li>▪ Freely definable value between: 0 to 20.5 mA</li> </ul>
---------------------	---

**Pulse/frequency/switch output**

<b>Pulse output</b>	
<b>Failure mode</b>	Choose from: <ul style="list-style-type: none"> <li>▪ Actual value</li> <li>▪ No pulses</li> </ul>
<b>Frequency output</b>	
<b>Failure mode</b>	Choose from: <ul style="list-style-type: none"> <li>▪ Actual value</li> <li>▪ 0 Hz</li> <li>▪ Defined value (<math>f_{max} 2</math> to 12 500 Hz)</li> </ul>
<b>Switch output</b>	
<b>Failure mode</b>	Choose from: <ul style="list-style-type: none"> <li>▪ Current status</li> <li>▪ Open</li> <li>▪ Closed</li> </ul>

**Relay output**

<b>Failure mode</b>	Choose from: <ul style="list-style-type: none"> <li>▪ Current status</li> <li>▪ Open</li> <li>▪ Closed</li> </ul>
---------------------	---

**Local display**



<b>Plain text display</b>	With information on cause and remedial measures
<b>Backlight</b>	Red backlighting indicates a device error.

 Status signal as per NAMUR recommendation NE 107

**Interface/protocol**

- Via digital communication:
  - HART protocol
  - FOUNDATION Fieldbus
  - PROFIBUS PA
  - PROFIBUS DP
  - Modbus RS485
  - EtherNet/IP
  - PROFINET
  - PROFINET with Ethernet-APL
- Via service interface
  - CDI-RJ45 service interface
  - WLAN interface

Plain text display	With information on cause and remedial measures
--------------------	---

 Additional information on remote operation →  110

**Web browser**

Plain text display	With information on cause and remedial measures
--------------------	---

**Light emitting diodes (LED)**

<b>Status information</b>	<p>Status indicated by various light emitting diodes</p> <p>The following information is displayed depending on the device version:</p> <ul style="list-style-type: none"> <li>▪ Supply voltage active</li> <li>▪ Data transmission active</li> <li>▪ Device alarm/error has occurred</li> <li>▪ EtherNet/IP network available</li> <li>▪ EtherNet/IP connection established</li> <li>▪ PROFINET network available</li> <li>▪ PROFINET connection established</li> <li>▪ PROFINET blinking feature</li> </ul>
---------------------------	---

**Load**                      Output signal →  16

**Ex connection data****Safety-related values**

Order code for "Output; input 1"	Output type	Safety-related values "Output; input 1"	
		26 (+)	27 (-)
Option <b>BA</b>	Current output 4 to 20 mA HART	$U_N = 30 V_{DC}$ $U_M = 250 V_{AC}$	
Option <b>GA</b>	PROFIBUS PA	$U_N = 32 V_{DC}$ $U_M = 250 V_{AC}$	
Option <b>LA</b>	PROFIBUS DP	$U_N = 32 V_{DC}$ $U_M = 250 V_{AC}$	
Option <b>MA</b>	Modbus RS485	$U_N = 30 V_{DC}$ $U_M = 250 V_{AC}$	
Option <b>SA</b>	FOUNDATION Fieldbus	$U_N = 32 V_{DC}$ $U_M = 250 V_{AC}$	
Option <b>NA</b>	EtherNet/IP	$U_N = 30 V_{DC}$ $U_M = 250 V_{AC}$	

Order code for "Output; input 1"	Output type	Safety-related values "Output; input 1"	
		26 (+)	27 (-)
Option RA	PROFINET	$U_N = 30 V_{DC}$ $U_M = 250 V_{AC}$	
Option RB	PROFINET with Ethernet- APL	APL port profile SLAX SPE PoDL classes 10, 11, 12 $U_N = 30 V_{DC}$ $U_M = 250 V_{AC}$	

Order code for "Output; input 2"; "Output; input 3"	Output type	Safety-related values			
		Output; input 2		Output; input 3	
		24 (+)	25 (-)	22 (+)	23 (-)
Option B	Current output 4 to 20 mA	$U_N = 30 V_{DC}$ $U_M = 250 V_{AC}$			
Option D	User-configurable input/ output	$U_N = 30 V_{DC}$ $U_M = 250 V_{AC}$			
Option E	Pulse/frequency/switch output	$U_N = 30 V_{DC}$ $U_M = 250 V_{AC}$			
Option F	Double pulse output	$U_N = 30 V_{DC}$ $U_M = 250 V_{AC}$			
Option H	Relay output	$U_N = 30 V_{DC}$ $I_N = 100 mA_{DC}/500 mA_{AC}$ $U_M = 250 V_{AC}$			
Option I	Current input 4 to 20 mA	$U_N = 30 V_{DC}$ $U_M = 250 V_{AC}$			
Option J	Status input	$U_N = 30 V_{DC}$ $U_M = 250 V_{AC}$			

**Intrinsically safe values**

Order code "Output; input 1"	Output type	Intrinsically safe values "Output; input 1"	
		26 (+)	27 (-)
Option CA	Current output 4 to 20 mA HART Ex i passive	$U_i = 30 V$ $I_i = 100 mA$ $P_i = 1.25 W$ $L_i = 0 \mu H$ $C_i = 6 nF$	
Option CC	Current output 4 to 20 mA HART Ex i active	<b>Ex ia</b> <sup>1)</sup> $U_0 = 21.8 V$ $I_0 = 90 mA$ $P_0 = 491 mW$ $L_0 = 4.1 mH (IIC)/15 mH (IIB)$ $C_0 = 160 nF (IIC)/1160 nF (IIB)$  $U_i = 30 V$ $I_i = 10 mA$ $P_i = 0.3 W$ $L_i = 5 \mu H$ $C_i = 6 nF$	<b>Ex ic</b> <sup>2)</sup> $U_0 = 21.8 V$ $I_0 = 90 mA$ $P_0 = 491 mW$ $L_0 = 9 mH (IIC)/39 mH (IIB)$ $C_0 = 600 nF (IIC)/4000 nF (IIB)$

Order code "Output; input 1"	Output type	Intrinsically safe values "Output; input 1"	
		26 (+)	27 (-)
Option HA	PROFIBUS PA Ex i (FISCO Field Device)	<b>Ex ia</b> <sup>1)</sup> U <sub>i</sub> = 30 V I <sub>i</sub> = 570 mA P <sub>i</sub> = 8.5 W L <sub>i</sub> = 10 µH C <sub>i</sub> = 5 nF	<b>Ex ic</b> <sup>2)</sup> U <sub>i</sub> = 32 V I <sub>i</sub> = 570 mA P <sub>i</sub> = 8.5 W L <sub>i</sub> = 10 µH C <sub>i</sub> = 5 nF
Option TA	FOUNDATION Fieldbus Ex i	<b>Ex ia</b> <sup>1)</sup> U <sub>i</sub> = 30 V I <sub>i</sub> = 570 mA P <sub>i</sub> = 8.5 W L <sub>i</sub> = 10 µH C <sub>i</sub> = 5 nF	<b>Ex ic</b> <sup>2)</sup> U <sub>i</sub> = 32 V I <sub>i</sub> = 570 mA P <sub>i</sub> = 8.5 W L <sub>i</sub> = 10 µH C <sub>i</sub> = 5 nF
Option RC	PROFINET with Ethernet- APL Ex i	<b>Ex ia</b> <sup>1)</sup> 2-WISE power load APL port profile SLAA	<b>Ex ic</b> <sup>2)</sup> 2-WISE power load APL port profile SLAC

- 1) Only available for Proline 500 transmitter Zone 1; Class I, Division 1.  
2) Only available for transmitter Zone 2; Class I, Division 2.

Order code for "Output; input 2"; "Output; input 3"	Output type	Intrinsically safe values or NIFW values			
		Output; input 2		Output; input 3	
		24 (+)	25 (-)	22 (+)	23 (-)
Option C	Current output 4 to 20 mA Ex i passive	U <sub>i</sub> = 30 V I <sub>i</sub> = 100 mA P <sub>i</sub> = 1.25 W L <sub>i</sub> = 0 C <sub>i</sub> = 0			
Option G	Pulse/frequency/switch output Ex i passive	U <sub>i</sub> = 30 V I <sub>i</sub> = 100 mA P <sub>i</sub> = 1.25 W L <sub>i</sub> = 0 C <sub>i</sub> = 0			

**Low flow cut off** The switch points for low flow cut off are user-selectable.

**Galvanic isolation** The outputs are galvanically isolated:

- from the power supply
- from one another
- from the potential equalization (PE) terminal

**Protocol-specific data** HART



<b>Manufacturer ID</b>	0x11
<b>Device type ID</b>	0x3B
<b>HART protocol revision</b>	7
<b>Device description files (DTM, DD)</b>	Information and files under: <a href="http://www.endress.com">www.endress.com</a>
<b>HART load</b>	Min. 250 Ω
<b>System integration</b>	Information on system integration: Operating Instructions → 131. <ul style="list-style-type: none"> <li>▪ Measured variables via HART protocol</li> <li>▪ Burst Mode functionality</li> </ul>

## FOUNDATION Fieldbus

Manufacturer ID	0x452B48 (hex)
Ident number	0x103B (hex)
Device revision	1
DD revision	Information and files under:
CFF revision	<ul style="list-style-type: none"> <li>▪ <a href="http://www.endress.com">www.endress.com</a></li> <li>▪ <a href="http://www.fieldcommgroup.org">www.fieldcommgroup.org</a></li> </ul>
Interoperability Test Kit (ITK)	Version 6.2.0
ITK Test Campaign Number	Information: <ul style="list-style-type: none"> <li>▪ <a href="http://www.endress.com">www.endress.com</a></li> <li>▪ <a href="http://www.fieldcommgroup.org">www.fieldcommgroup.org</a></li> </ul>
Link Master capability (LAS)	Yes
Choice of "Link Master" and "Basic Device"	Yes Factory setting: Basic Device
Node address	Factory setting: 247 (0xF7)
Supported functions	The following methods are supported: <ul style="list-style-type: none"> <li>▪ Restart</li> <li>▪ ENP Restart</li> <li>▪ Diagnostic</li> <li>▪ Set to OOS</li> <li>▪ Set to AUTO</li> <li>▪ Read trend data</li> <li>▪ Read event logbook</li> </ul>
<b>Virtual Communication Relationships (VCRs)</b>	
Number of VCRs	44
Number of link objects in VFD	50
Permanent entries	1
Client VCRs	0
Server VCRs	10
Source VCRs	43
Sink VCRs	0
Subscriber VCRs	43
Publisher VCRs	43
<b>Device Link Capabilities</b>	
Slot time	4
Min. delay between PDU	8
Max. response delay	16
System integration	Information regarding system integration: Operating Instructions →  131. <ul style="list-style-type: none"> <li>▪ Cyclic data transmission</li> <li>▪ Description of the modules</li> <li>▪ Execution times</li> <li>▪ Methods</li> </ul>

## PROFIBUS DP



Manufacturer ID	0x11
Ident number	0x156F
Profile version	3.02

<b>Device description files (GSD, DTM, DD)</b>	Information and files under: <ul style="list-style-type: none"> <li>▪ <a href="https://www.endress.com/download">https://www.endress.com/download</a> On the device product page: PRODUCTS → Product Finder → Links</li> <li>▪ <a href="https://www.profibus.com">https://www.profibus.com</a></li> </ul>
<b>Supported functions</b>	<ul style="list-style-type: none"> <li>▪ Identification &amp; Maintenance Simplest device identification on the part of the control system and nameplate</li> <li>▪ PROFIBUS upload/download Reading and writing parameters is up to ten times faster with PROFIBUS upload/download</li> <li>▪ Condensed status Simplest and self-explanatory diagnostic information by categorizing diagnostic messages that occur</li> </ul>
<b>Configuration of the device address</b>	<ul style="list-style-type: none"> <li>▪ DIP switches on the I/O electronics module</li> <li>▪ Via operating tools (e.g. FieldCare)</li> </ul>
<b>Compatibility with earlier model</b>	<p>If the device is replaced, the measuring device Promass 300 supports the compatibility of the cyclic data with previous models. It is not necessary to adjust the engineering parameters of the PROFIBUS network with the Promass 300 GSD file.</p> <p>Previous model: Promass 83 PROFIBUS DP</p> <ul style="list-style-type: none"> <li>▪ ID No.: 1529 (hex)</li> <li>▪ Extended GSD file: EH3x1529.gsd</li> <li>▪ Standard GSD file: EH3_1529.gsd</li> </ul> <p> Description of the function scope of compatibility: Operating Instructions →  131.</p>
<b>System integration</b>	<p>Information regarding system integration: Operating Instructions →  131.</p> <ul style="list-style-type: none"> <li>▪ Cyclic data transmission</li> <li>▪ Block model</li> <li>▪ Description of the modules</li> </ul>

## PROFIBUS PA



<b>Manufacturer ID</b>	0x11
<b>Ident number</b>	0x156D
<b>Profile version</b>	3.02
<b>Device description files (GSD, DTM, DD)</b>	Information and files under: <ul style="list-style-type: none"> <li>▪ <a href="https://www.endress.com/download">https://www.endress.com/download</a> On the device product page: PRODUCTS → Product Finder → Links</li> <li>▪ <a href="https://www.profibus.com">https://www.profibus.com</a></li> </ul>
<b>Supported functions</b>	<ul style="list-style-type: none"> <li>▪ Identification &amp; Maintenance Simplest device identification on the part of the control system and nameplate</li> <li>▪ PROFIBUS upload/download Reading and writing parameters is up to ten times faster with PROFIBUS upload/download</li> <li>▪ Condensed status Simplest and self-explanatory diagnostic information by categorizing diagnostic messages that occur</li> </ul>
<b>Configuration of the device address</b>	<ul style="list-style-type: none"> <li>▪ DIP switches on the I/O electronics module</li> <li>▪ Local display</li> <li>▪ Via operating tools (e.g. FieldCare)</li> </ul>



<p><b>Compatibility with earlier model</b></p>	<p>If the device is replaced, the measuring device Promass 300 supports the compatibility of the cyclic data with previous models. It is not necessary to adjust the engineering parameters of the PROFIBUS network with the Promass 300 GSD file.</p> <p>Earlier models:</p> <ul style="list-style-type: none"> <li>▪ Promass 80 PROFIBUS PA             <ul style="list-style-type: none"> <li>▪ ID No.: 1528 (hex)</li> <li>▪ Extended GSD file: EH3x1528.gsd</li> <li>▪ Standard GSD file: EH3_1528.gsd</li> </ul> </li> <li>▪ Promass 83 PROFIBUS PA             <ul style="list-style-type: none"> <li>▪ ID No.: 152A (hex)</li> <li>▪ Extended GSD file: EH3x152A.gsd</li> <li>▪ Standard GSD file: EH3_152A.gsd</li> </ul> </li> </ul> <p> Description of the function scope of compatibility: Operating Instructions →  131.</p>
<p><b>System integration</b></p>	<p>Information regarding system integration: Operating Instructions →  131.</p> <ul style="list-style-type: none"> <li>▪ Cyclic data transmission</li> <li>▪ Block model</li> <li>▪ Description of the modules</li> </ul>

**Modbus RS485**

<p><b>Protocol</b></p>	<p>Modbus Applications Protocol Specification V1.1</p>
<p><b>Response times</b></p>	<ul style="list-style-type: none"> <li>▪ Direct data access: typically 25 to 50 ms</li> <li>▪ Auto-scan buffer (data range): typically 3 to 5 ms</li> </ul>
<p><b>Device type</b></p>	<p>Slave</p>
<p><b>Slave address range</b></p>	<p>1 to 247</p>
<p><b>Broadcast address range</b></p>	<p>0</p>
<p><b>Function codes</b></p>	<ul style="list-style-type: none"> <li>▪ 03: Read holding register</li> <li>▪ 04: Read input register</li> <li>▪ 06: Write single registers</li> <li>▪ 08: Diagnostics</li> <li>▪ 16: Write multiple registers</li> <li>▪ 23: Read/write multiple registers</li> </ul>
<p><b>Broadcast messages</b></p>	<p>Supported by the following function codes:</p> <ul style="list-style-type: none"> <li>▪ 06: Write single registers</li> <li>▪ 16: Write multiple registers</li> <li>▪ 23: Read/write multiple registers</li> </ul>
<p><b>Supported baud rate</b></p>	<ul style="list-style-type: none"> <li>▪ 1 200 BAUD</li> <li>▪ 2 400 BAUD</li> <li>▪ 4 800 BAUD</li> <li>▪ 9 600 BAUD</li> <li>▪ 19 200 BAUD</li> <li>▪ 38 400 BAUD</li> <li>▪ 57 600 BAUD</li> <li>▪ 115 200 BAUD</li> </ul>
<p><b>Data transfer mode</b></p>	<ul style="list-style-type: none"> <li>▪ ASCII</li> <li>▪ RTU</li> </ul>
<p><b>Data access</b></p>	<p>Each device parameter can be accessed via Modbus RS485.</p> <p> For Modbus register information</p>

<b>Compatibility with earlier model</b>	<p>If the device is replaced, the measuring device Promass 300 supports the compatibility of the Modbus registers for the process variables and the diagnostic information with the previous model Promass 83. It is not necessary to change the engineering parameters in the automation system.</p> <p> Description of the function scope of compatibility: Operating Instructions →  131.</p>
<b>System integration</b>	<p>Information on system integration: Operating Instructions →  131.</p> <ul style="list-style-type: none"> <li>▪ Modbus RS485 information</li> <li>▪ Function codes</li> <li>▪ Register information</li> <li>▪ Response time</li> <li>▪ Modbus data map</li> </ul>

### EtherNet/IP

<b>Protocol</b>	<ul style="list-style-type: none"> <li>▪ The CIP Networks Library Volume 1: Common Industrial Protocol</li> <li>▪ The CIP Networks Library Volume 2: EtherNet/IP Adaptation of CIP</li> </ul>
<b>Communication type</b>	<ul style="list-style-type: none"> <li>▪ 10Base-T</li> <li>▪ 100Base-TX</li> </ul>
<b>Device profile</b>	Generic device (product type: 0x2B)
<b>Manufacturer ID</b>	0x000049E
<b>Device type ID</b>	0x103B
<b>Baud rates</b>	Automatic <sup>10</sup> / <sub>100</sub> Mbit with half-duplex and full-duplex detection
<b>Polarity</b>	Auto-polarity for automatic correction of crossed TxD and RxD pairs
<b>Supported CIP connections</b>	Max. 3 connections
<b>Explicit connections</b>	Max. 6 connections
<b>I/O connections</b>	Max. 6 connections (scanner)
<b>Configuration options for measuring device</b>	<ul style="list-style-type: none"> <li>▪ DIP switches on the electronics module for IP addressing</li> <li>▪ Manufacturer-specific software (FieldCare)</li> <li>▪ Add-on Profile Level 3 for Rockwell Automation control systems</li> <li>▪ Web browser</li> <li>▪ Electronic Data Sheet (EDS) integrated in the measuring device</li> </ul>
<b>Configuration of the EtherNet interface</b>	<ul style="list-style-type: none"> <li>▪ Speed: 10 MBit, 100 MBit, auto (factory setting)</li> <li>▪ Duplex: half-duplex, full-duplex, auto (factory setting)</li> </ul>
<b>Configuration of the device address</b>	<ul style="list-style-type: none"> <li>▪ DIP switches on the electronics module for IP addressing (last octet)</li> <li>▪ DHCP</li> <li>▪ Manufacturer-specific software (FieldCare)</li> <li>▪ Add-on Profile Level 3 for Rockwell Automation control systems</li> <li>▪ Web browser</li> <li>▪ EtherNet/IP tools, e.g. RSLinx (Rockwell Automation)</li> </ul>
<b>Device Level Ring (DLR)</b>	Yes
<b>System integration</b>	<p>Information regarding system integration: Operating Instructions →  131.</p> <ul style="list-style-type: none"> <li>▪ Cyclic data transmission</li> <li>▪ Block model</li> <li>▪ Input and output groups</li> </ul>

### PROFINET

<b>Protocol</b>	Application layer protocol for decentral device periphery and distributed automation, Version 2.3
<b>Communication type</b>	100 MBit/s
<b>Conformance Class</b>	Conformance Class B
<b>Netload Class</b>	Netload Class 2 0 Mbps

<b>Baud rates</b>	Automatic 100 Mbit/s with full-duplex detection
<b>Cycle times</b>	From 8 ms
<b>Polarity</b>	Auto-polarity for automatic correction of crossed TxD and RxD pairs
<b>Media Redundancy Protocol (MRP)</b>	Yes
<b>System redundancy support</b>	System redundancy S2 (2 AR with 1 NAP)
<b>Device profile</b>	Application interface identifier 0xF600 Generic device
<b>Manufacturer ID</b>	0x11
<b>Device type ID</b>	0x843B
<b>Device description files (GSD, DTM, DD)</b>	Information and files under: <ul style="list-style-type: none"> <li>▪ <a href="http://www.endress.com">www.endress.com</a> On the product page for the device: Documents/Software → Device drivers</li> <li>▪ <a href="http://www.profibus.com">www.profibus.com</a></li> </ul>
<b>Supported connections</b>	<ul style="list-style-type: none"> <li>▪ 2 x AR (IO Controller AR)</li> <li>▪ 1 x AR (IO-Supervisor Device AR connection allowed)</li> <li>▪ 1 x Input CR (Communication Relation)</li> <li>▪ 1 x Output CR (Communication Relation)</li> <li>▪ 1 x Alarm CR (Communication Relation)</li> </ul>
<b>Configuration options for measuring device</b>	<ul style="list-style-type: none"> <li>▪ DIP switches on the electronics module, for device name assignment (last part)</li> <li>▪ Asset management software (FieldCare, DeviceCare, Field Xpert)</li> <li>▪ Integrated Web server via Web browser and IP address</li> <li>▪ Device master file (GSD), can be read out via the integrated Web server of the measuring device.</li> <li>▪ Onsite operation</li> </ul>
<b>Configuration of the device name</b>	<ul style="list-style-type: none"> <li>▪ DIP switches on the electronics module, for device name assignment (last part)</li> <li>▪ DCP protocol</li> <li>▪ Asset management software (FieldCare, DeviceCare, Field Xpert)</li> <li>▪ Integrated Web server</li> </ul>
<b>Supported functions</b>	<ul style="list-style-type: none"> <li>▪ Identification &amp; Maintenance, simple device identifier via: <ul style="list-style-type: none"> <li>▪ Control system</li> <li>▪ Nameplate</li> </ul> </li> <li>▪ Measured value status The process variables are communicated with a measured value status</li> <li>▪ Blinking feature via the local display for simple device identification and assignment</li> <li>▪ Device operation via asset management software (e.g. FieldCare, DeviceCare, SIMATIC PDM)</li> </ul>
<b>System integration</b>	Information regarding system integration: Operating Instructions →  131. <ul style="list-style-type: none"> <li>▪ Cyclic data transmission</li> <li>▪ Overview and description of the modules</li> <li>▪ Status coding</li> <li>▪ Startup configuration</li> <li>▪ Factory setting</li> </ul>

**PROFINET with Ethernet-APL**

<b>Protocol</b>	Application layer protocol for decentral device periphery and distributed automation, Version 2.4
<b>Communication type</b>	Ethernet Advanced Physical Layer 10BASE-T1L
<b>Conformance Class</b>	Conformance Class B (PA)
<b>Netload Class</b>	Netload Class 2 0 Mbps
<b>Baud rates</b>	10 Mbit/s Full-duplex
<b>Cycle times</b>	64 ms

<b>Polarity</b>	Automatic correction of crossed "APL signal +" and "APL signal -" signal lines
<b>Media Redundancy Protocol (MRP)</b>	Not possible (point-to-point connection to APL field switch)
<b>System redundancy support</b>	System redundancy S2 (2 AR with 1 NAP)
<b>Device profile</b>	PROFINET PA profile 4 (Application interface identifier API: 0x9700)
<b>Manufacturer ID</b>	0x11
<b>Device type ID</b>	0xA43B
<b>Device description files (GSD, DTM, FDI)</b>	Information and files under: <ul style="list-style-type: none"> <li>▪ <a href="http://www.endress.com/download">www.endress.com/download</a> On the device product page: PRODUCTS → Product Finder → Links</li> <li>▪ <a href="http://www.profibus.com">www.profibus.com</a></li> </ul>
<b>Supported connections</b>	<ul style="list-style-type: none"> <li>▪ 2x AR (IO Controller AR)</li> <li>▪ 2x AR (IO Supervisor Device AR connection allowed)</li> </ul>
<b>Configuration options for measuring device</b>	<ul style="list-style-type: none"> <li>▪ DIP switches on the electronics module, for device name assignment (last part)</li> <li>▪ Asset management software (FieldCare, DeviceCare, Field Xpert)</li> <li>▪ Integrated Web server via Web browser and IP address</li> <li>▪ Device master file (GSD), can be read out via the integrated Web server of the measuring device.</li> <li>▪ Onsite operation</li> </ul>
<b>Configuration of the device name</b>	<ul style="list-style-type: none"> <li>▪ DIP switches on the electronics module, for device name assignment (last part)</li> <li>▪ DCP protocol</li> <li>▪ Asset management software (FieldCare, DeviceCare, Field Xpert)</li> <li>▪ Integrated Web server</li> </ul>
<b>Supported functions</b>	<ul style="list-style-type: none"> <li>▪ Identification &amp; Maintenance, simple device identifier via: <ul style="list-style-type: none"> <li>▪ Control system</li> <li>▪ Nameplate</li> </ul> </li> <li>▪ Measured value status The process variables are communicated with a measured value status</li> <li>▪ Blinking feature via the local display for simple device identification and assignment</li> <li>▪ Device operation via asset management software (e.g. FieldCare, DeviceCare, SIMATIC PDM with FDI package)</li> </ul>
<b>System integration</b>	Information regarding system integration: Operating Instructions →  131. <ul style="list-style-type: none"> <li>▪ Cyclic data transmission</li> <li>▪ Overview and description of the modules</li> <li>▪ Status coding</li> <li>▪ Startup configuration</li> <li>▪ Factory setting</li> </ul>

## Power supply

### Terminal assignment

#### Transmitter: supply voltage, input/outputs

##### HART

Supply voltage		Input/output 1		Input/output 2		Input/output 3	
1 (+)	2 (-)	26 (+)	27 (-)	24 (+)	25 (-)	22 (+)	23 (-)
The terminal assignment depends on the specific device version ordered → 14.							

##### FOUNDATION Fieldbus

Supply voltage		Input/output 1		Input/output 2		Input/output 3	
1 (+)	2 (-)	26 (A)	27 (B)	24 (+)	25 (-)	22 (+)	23 (-)
The terminal assignment depends on the specific device version ordered → 14.							

##### PROFIBUS DP

Supply voltage		Input/output 1		Input/output 2		Input/output 3	
1 (+)	2 (-)	26 (B)	27 (A)	24 (+)	25 (-)	22 (+)	23 (-)
The terminal assignment depends on the specific device version ordered → 14.							

##### PROFIBUS PA

Supply voltage		Input/output 1		Input/output 2		Input/output 3	
1 (+)	2 (-)	26 (B)	27 (A)	24 (+)	25 (-)	22 (+)	23 (-)
The terminal assignment depends on the specific device version ordered → 14.							

##### Modbus RS485

Supply voltage		Input/output 1		Input/output 2		Input/output 3	
1 (+)	2 (-)	26 (B)	27 (A)	24 (+)	25 (-)	22 (+)	23 (-)
The terminal assignment depends on the specific device version ordered → 14.							

##### PROFINET

Supply voltage		Input/output 1		Input/output 2		Input/output 3	
1 (+)	2 (-)	PROFINET (RJ45 connector)		24 (+)	25 (-)	22 (+)	23 (-)
The terminal assignment depends on the specific device version ordered → 14.							

##### PROFINET with Ethernet-APL

Supply voltage		Input/output 1		Input/output 2		Input/output 3	
1 (+)	2 (-)	PROFINET (RJ45 connector)		24 (+)	25 (-)	22 (+)	23 (-)
The terminal assignment depends on the specific device version ordered → 14.							

## EtherNet/IP

Supply voltage		Input/output 1	Input/output 2		Input/output 3	
1 (+)	2 (-)	EtherNet/IP (RJ45 connector)	24 (+)	25 (-)	22 (+)	23 (-)
The terminal assignment depends on the specific device version ordered → 14.						



Terminal assignment of the remote display and operating module → 37.

## Available device plugs



Device plugs may not be used in hazardous areas!

**Device plugs for fieldbus systems:**

Order code for "Input; output 1"

- Option **SA** "FOUNDATION Fieldbus" → 34
- Option **GA** "PROFIBUS PA" → 34
- Option **NA** "EtherNet/IP" → 34
- Option **RA** "PROFINET" → 35
- Option **RB** "PROFINET with Ethernet-APL" → 35

**Device plug for connecting to the service interface:**

Order code for "Accessory mounted"

Option **NB**, adapter RJ45 M12 (service interface) → 48

**Order code for "Input; output 1", option SA "FOUNDATION Fieldbus"**

Order code for "Electrical connection"	Cable entry/connection → 36	
	2	3
M, 3, 4, 5	7/8" connector	-

**Order code for "Input; output 1", option GA "PROFIBUS PA"**

Order code for "Electrical connection"	Cable entry/connection → 36	
	2	3
L, N, P, U	Connector M12 × 1	-

**Order code for "Input; output 1", option NA "EtherNet/IP"**

Order code for "Electrical connection"	Cable entry/connection → 36	
	2	3
L, N, P, U	Connector M12 × 1	-
R <sup>1) 2)</sup> , S <sup>1) 2)</sup> , T <sup>1) 2)</sup> , V <sup>1) 2)</sup>	Connector M12 × 1	Connector M12 × 1

- 1) Cannot be combined with an external WLAN antenna (order code for "Enclosed accessories", option P8) of an RJ45 M12 adapter for the service interface (order code for "Accessories mounted", option NB) or of the remote display and operating module DKX001
- 2) Suitable for integrating the device in a ring topology.

**Order code for "Input; output 1", option RA "PROFINET"**

Order code for "Electrical connection"	Cable entry/connection → 36	
	2	3
L, N, P, U	Connector M12 × 1	-
R <sup>1) 2)</sup> , S <sup>1) 2)</sup> , T <sup>1) 2)</sup> , V <sup>1) 2)</sup>	Connector M12 × 1	Connector M12 × 1

- 1) Cannot be combined with an external WLAN antenna (order code for "Enclosed accessories", option P8) of an RJ45 M12 adapter for the service interface (order code for "Accessories mounted", option NB) or of the remote display and operating module DKX001.
- 2) Suitable for integrating the device in a ring topology.

**Order code for "Input; output 1", option RB "PROFINET with Ethernet-APL"**

Order code "Electrical connection"	Cable entry/connection → 36	
	2	3
L, N, P, U	M12 plug × 1	-

**Order code for "Accessory mounted", option NB "Adapter RJ45 M12 (service interface)"**

Order code "Accessory mounted"	Cable entry/coupling → 36	
	Cable entry 2	Cable entry 3
NB	Plug M12 × 1	-

**Supply voltage**

Order code for "Power supply"	Terminal voltage		Frequency range
	DC	AC	
Option D	DC 24 V	±20%	-
Option E	AC 100 to 240 V	-15 to +10%	50/60 Hz
Option I	DC 24 V	±20%	-
	AC 100 to 240 V	-15 to +10%	50/60 Hz

**Power consumption**

**Transmitter**

Max. 10 W (active power)

<b>switch-on current</b>	Max. 36 A (<5 ms) as per NAMUR Recommendation NE 21
--------------------------	---

**Current consumption**

**Transmitter**

- Max. 400 mA (24 V)
- Max. 200 mA (110 V, 50/60 Hz; 230 V, 50/60 Hz)

**Power supply failure**

- Totalizers stop at the last value measured.
- Depending on the device version, the configuration is retained in the device memory or in the pluggable data memory (HistoROM DAT).
- Error messages (incl. total operated hours) are stored.



**Overcurrent protection element**

The device must be operated with a dedicated circuit breaker, as it does not have an ON/OFF switch of its own.

- The circuit breaker must be easy to reach and labeled accordingly.
- Permitted nominal current of the circuit breaker: 2 A up to maximum 10 A.

## Electrical connection

## Transmitter connection

- i** ■ Terminal assignment →  33
- Device plugs available →  34

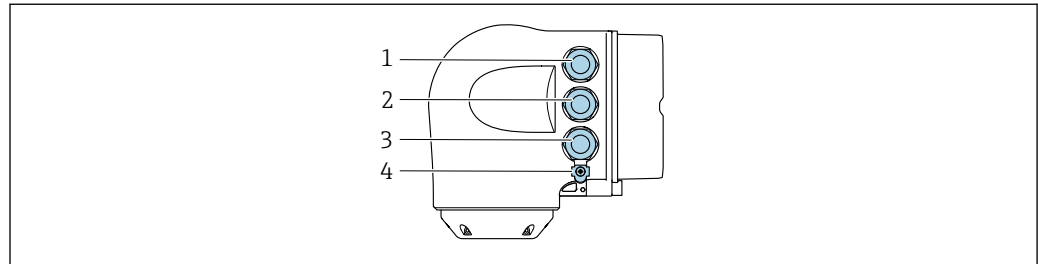

A0026781

- 1 Terminal connection for supply voltage
- 2 Terminal connection for signal transmission, input/output
- 3 Terminal connection for signal transmission, input/output or terminal for network connection via service interface (CDI-RJ45); Optional: terminal connection for external WLAN antenna or connection for remote display and operating module DKX001
- 4 Terminal connection for potential equalization (PE)

- i** An adapter for the RJ45 to the M12 plug is optionally available:  
Order code for "Accessories", option **NB**: "Adapter RJ45 M12 (service interface)"

The adapter connects the service interface (CDI-RJ45) to an M12 plug mounted in the cable entry. The connection to the service interface can therefore be established via an M12 plug without opening the device.

- i** Network connection via service interface (CDI-RJ45) →  116

*Connecting in a ring topology*

Device versions with EtherNet/IP and PROFINET communication protocols can be integrated into a ring topology. The device is integrated via the terminal connection for signal transmission (output 1) and the connection to the service interface (CDI-RJ45).

- i** Integrate the transmitter into a ring topology:
  - EtherNet/IP
  - PROFINET

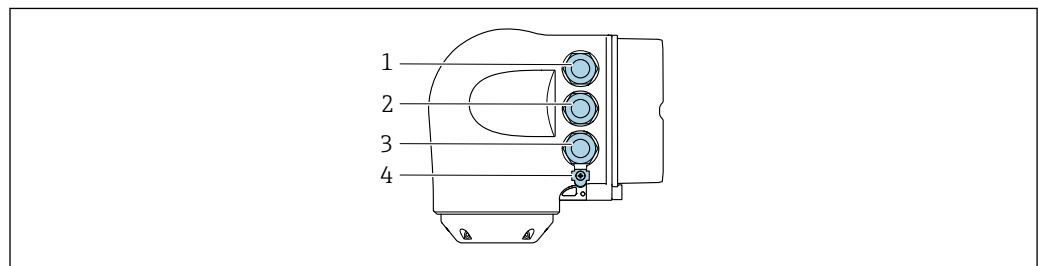

A0026781

- 1 Terminal connection for supply voltage
- 2 Terminal connection for signal transmission: PROFINET or EtherNet/IP (RJ45 connector)
- 3 Terminal connection to service interface (CDI-RJ45)
- 4 Terminal connection for potential equalization (PE)

- i** If the device has additional inputs/outputs, these are routed in parallel via the cable entry for connection to the service interface (CDI-RJ45).



### Connecting the remote display and operating module DKX001

- i** The remote display and operating module DKX001 is available as an optional extra → 128.
  - The remote display and operating module DKX001 is only available for the following housing versions, order code for "Housing":
    - Option A "Aluminum, coated"
    - Option L "Cast, stainless"
  - The measuring device is always supplied with a dummy cover when the remote display and operating module DKX001 is ordered directly with the measuring device. Display or operation at the transmitter is not possible in this case.
  - If ordered subsequently, the remote display and operating module DKX001 may not be connected at the same time as the existing measuring device display module. Only one display or operation unit may be connected to the transmitter at any one time.

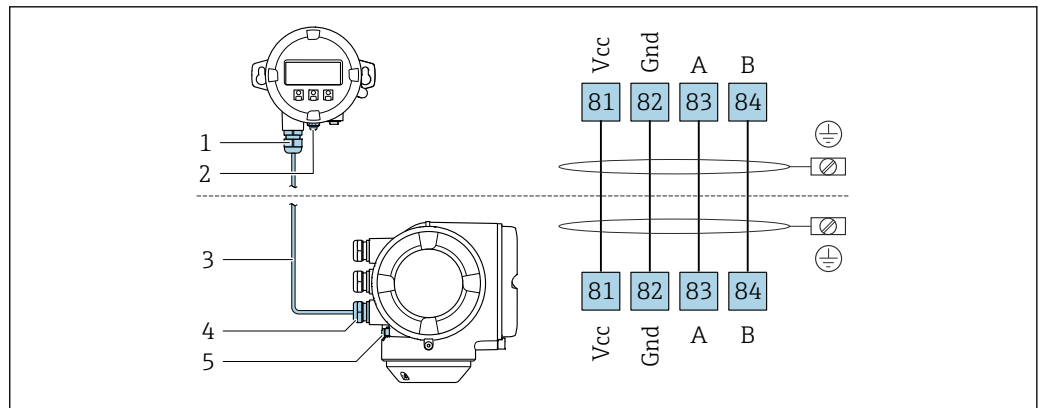

A0027518

- 1 Remote display and operating module DKX001
- 2 Terminal connection for potential equalization (PE)
- 3 Connecting cable
- 4 Measuring device
- 5 Terminal connection for potential equalization (PE)

### Connection examples

#### Current output 4 to 20 mA HART

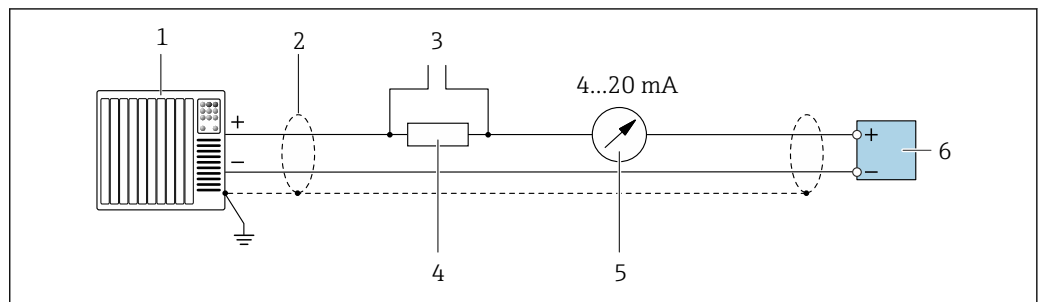

A0029055

- 2** Connection example for 4 to 20 mA HART current output (active)
  - 1 Automation system with current input (e.g. PLC)
  - 2 Cable shield provided at one end. The cable shield must be grounded at both ends to comply with EMC requirements; observe cable specifications → 48
  - 3 Connection for HART operating devices → 110
  - 4 Resistor for HART communication ( $\geq 250 \Omega$ ): observe maximum load → 16
  - 5 Analog display unit: observe maximum load → 16
  - 6 Transmitter

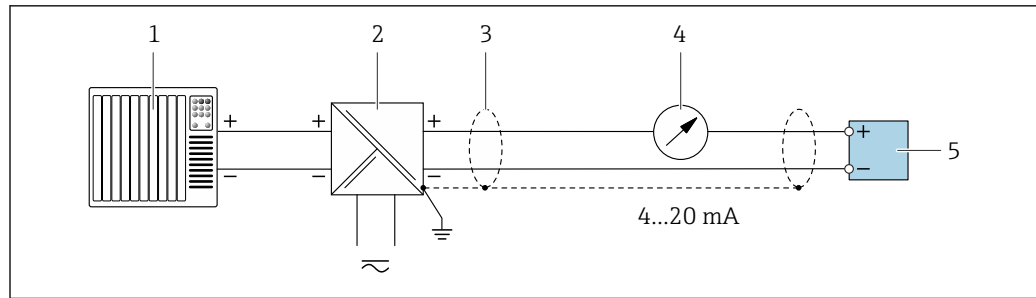

A0028762

3 Connection example for 4 to 20 mA HART current output (passive)

- 1 Automation system with current input (e.g. PLC)
- 2 Power supply
- 3 Cable shield provided at one end. The cable shield must be grounded at both ends to comply with EMC requirements; observe cable specifications → 48
- 4 Analog display unit: observe maximum load → 16
- 5 Transmitter

#### HART input

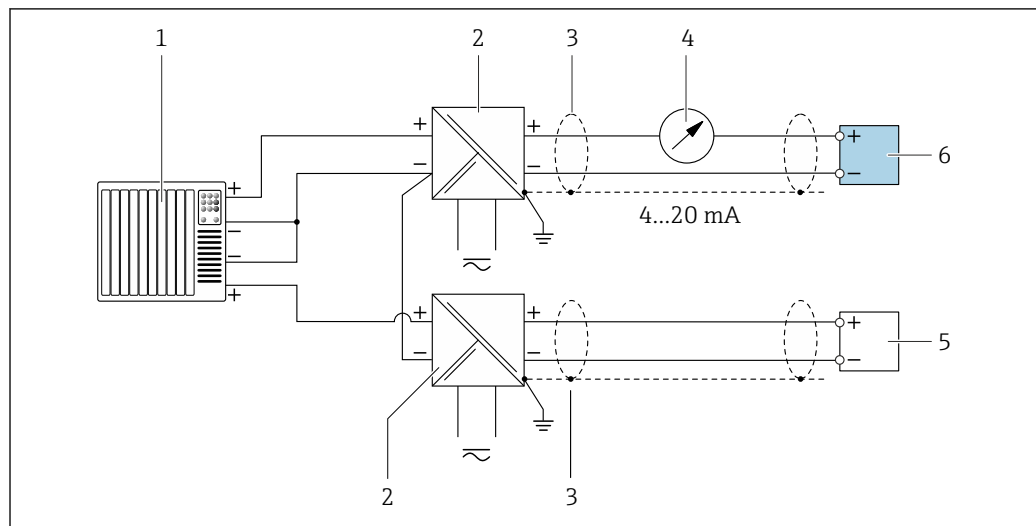

A0028763

4 Connection example for HART input with a common negative (passive)

- 1 Automation system with HART output (e.g. PLC)
- 2 Active barrier for power supply (e.g. RN221N)
- 3 Cable shield provided at one end. The cable shield must be grounded at both ends to comply with EMC requirements; observe cable specifications
- 4 Analog display unit: observe maximum load → 16
- 5 Pressure transmitter (e.g. Cerabar M, Cerabar S): see requirements
- 6 Transmitter

PROFIBUS PA

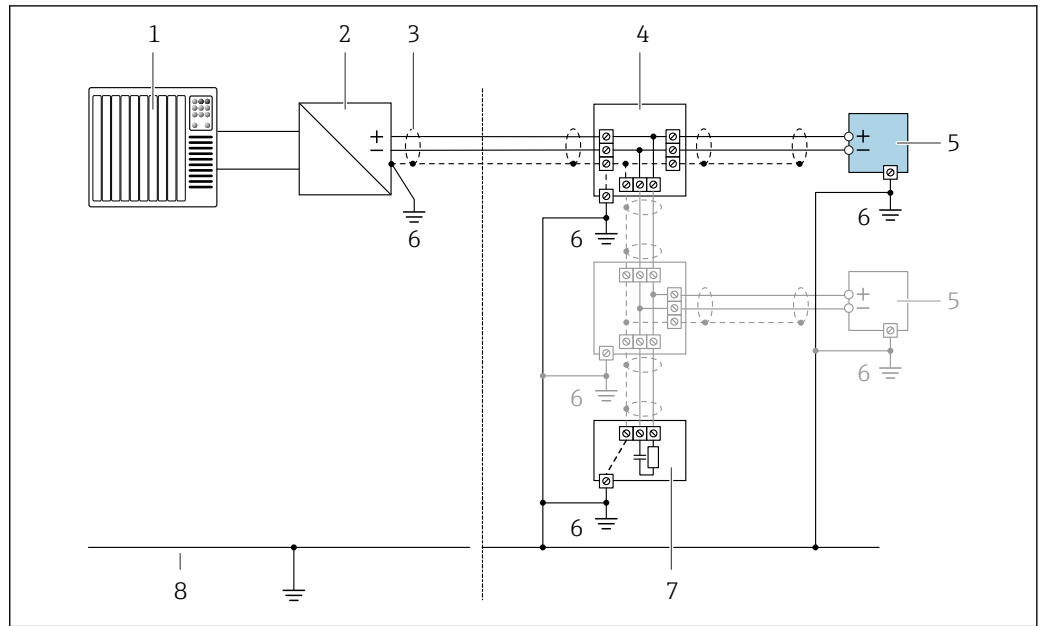

A0028768

5 Connection example for PROFIBUS PA

- 1 Control system (e.g. PLC)
- 2 PROFIBUS PA segment coupler
- 3 Cable shield provided at one end. The cable shield must be grounded at both ends to comply with EMC requirements; observe cable specifications
- 4 T-box
- 5 Measuring device
- 6 Local grounding
- 7 Bus terminator
- 8 Potential matching line

PROFIBUS DP

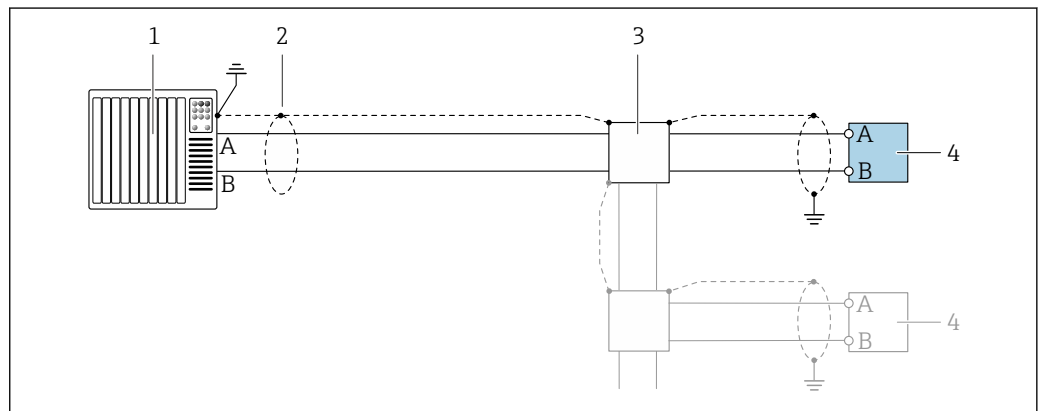

A0028765

6 Connection example for PROFIBUS DP, non-hazardous area and Zone 2/Div. 2

- 1 Control system (e.g. PLC)
- 2 Cable shield provided at one end. The cable shield must be grounded at both ends to comply with EMC requirements; observe cable specifications
- 3 Distribution box
- 4 Transmitter

**i** If baud rates > 1.5 Mbaud an EMC cable entry must be used and the cable shield must continue as far as the terminal wherever possible.

*EtherNet/IP*

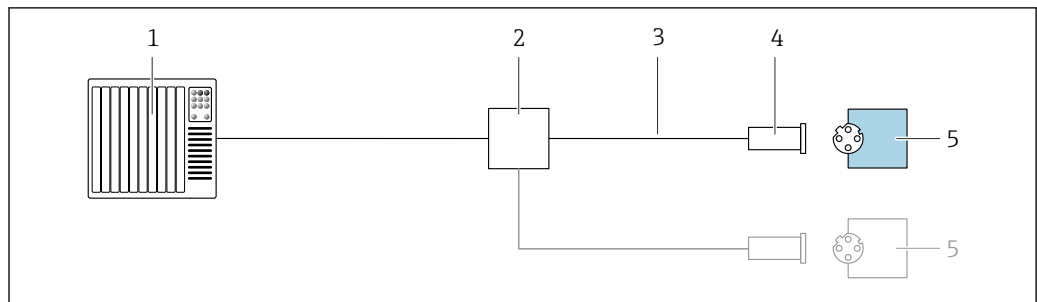

A0028767

**7** Connection example for EtherNet/IP

- 1 Control system (e.g. PLC)
- 2 Ethernet switch
- 3 Observe cable specifications
- 4 Device plug
- 5 Transmitter

*EtherNet/IP: DLR (Device Level Ring)*

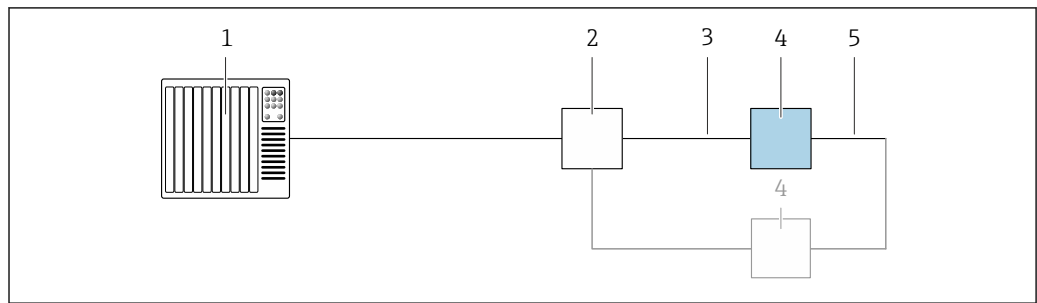

A0027544

- 1 Control system (e.g. PLC)
- 2 Ethernet switch
- 3 Observe cable specifications → 48
- 4 Transmitter
- 5 Connecting cable between the two transmitters

*PROFINET*

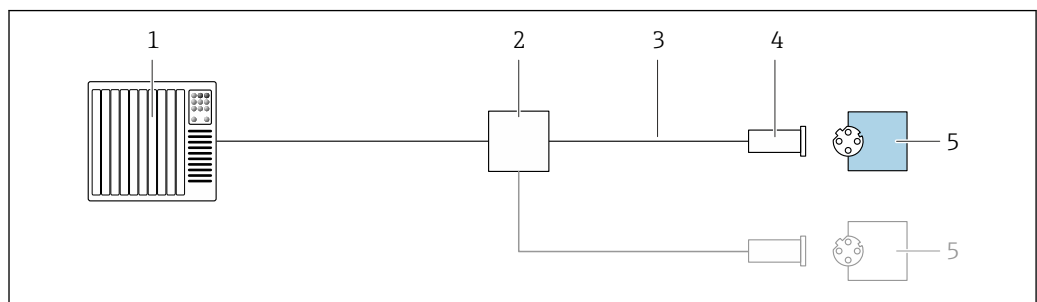

A0028767

**8** Connection example for PROFINET

- 1 Control system (e.g. PLC)
- 2 Ethernet switch
- 3 Observe cable specifications
- 4 Device plug
- 5 Transmitter

PROFINET with Ethernet-APL

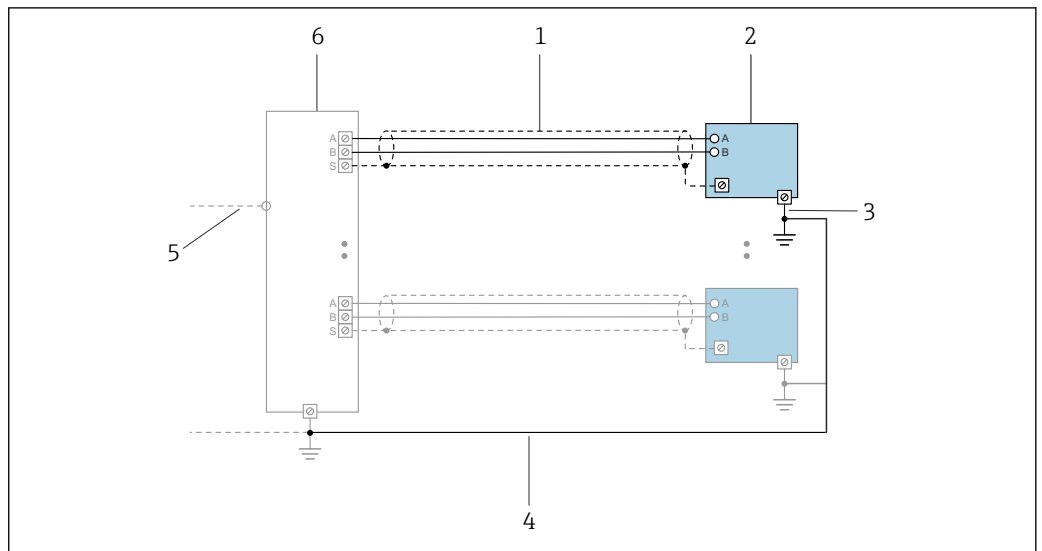

9 Connection example for PROFINET with Ethernet-APL

- 1 Cable shield
- 2 Measuring device
- 3 Local grounding
- 4 Potential equalization
- 5 Trunk or TCP
- 6 Field switch

PROFINET: MRP (Media Redundancy Protocol)

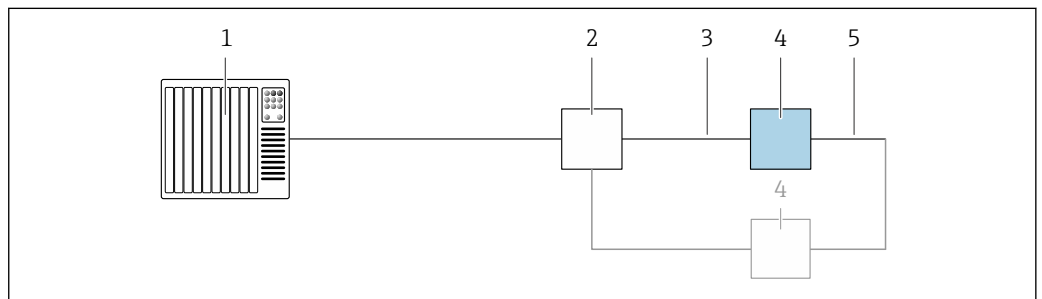

- 1 Control system (e.g. PLC)
- 2 Ethernet switch
- 3 Observe cable specifications → 48
- 4 Transmitter
- 5 Connecting cable between the two transmitters

PROFINET: system redundancy S2

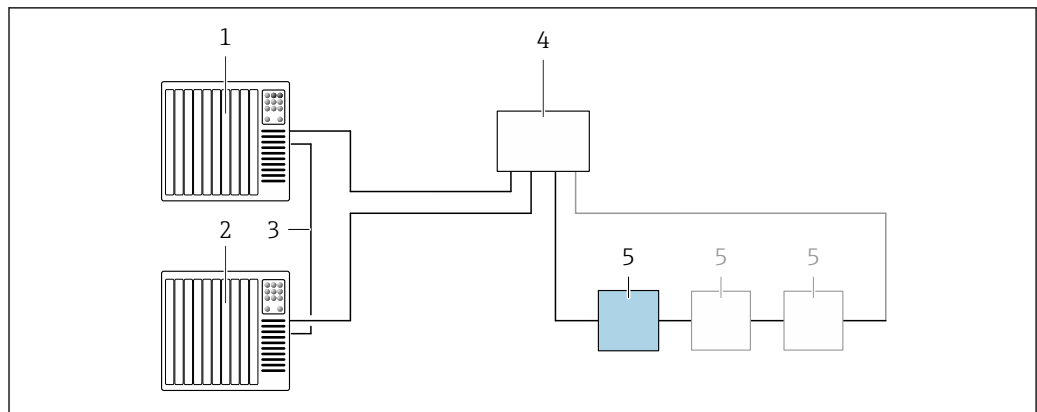

A0039553

10 Connection example for system redundancy S2

- 1 Control system 1 (e.g. PLC)
- 2 Synchronization of control systems
- 3 Control system 2 (e.g. PLC)
- 4 Industrial Ethernet Managed Switch
- 5 Transmitter

FOUNDATION Fieldbus

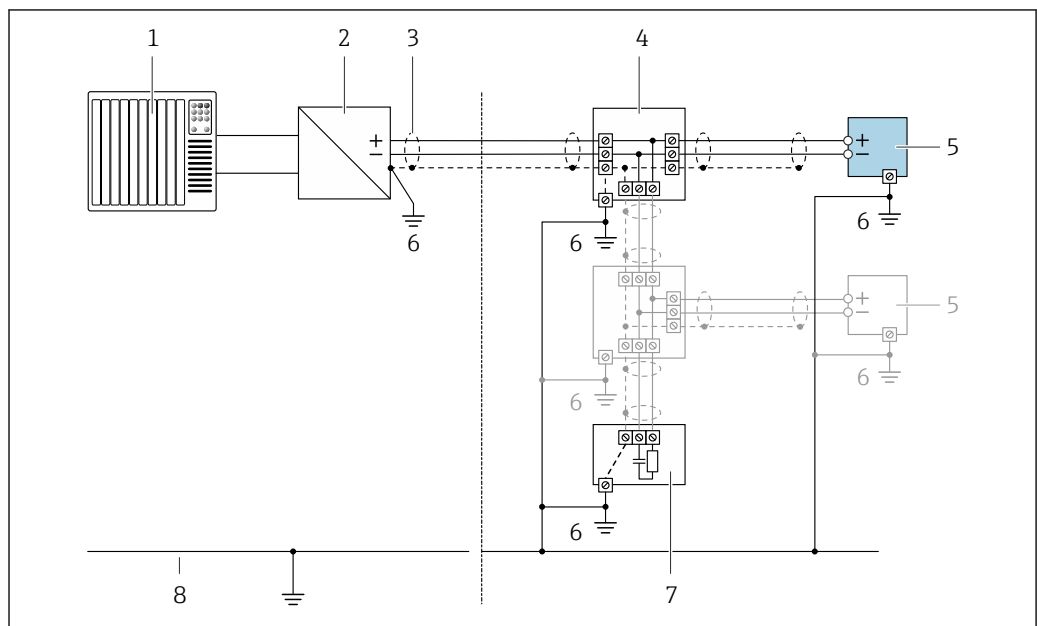

A0028768

11 Connection example for FOUNDATION Fieldbus

- 1 Control system (e.g. PLC)
- 2 Power Conditioner (FOUNDATION Fieldbus)
- 3 Cable shield provided at one end. The cable shield must be grounded at both ends to comply with EMC requirements; observe cable specifications
- 4 T-box
- 5 Measuring device
- 6 Local grounding
- 7 Bus terminator
- 8 Potential matching line

Modbus RS485

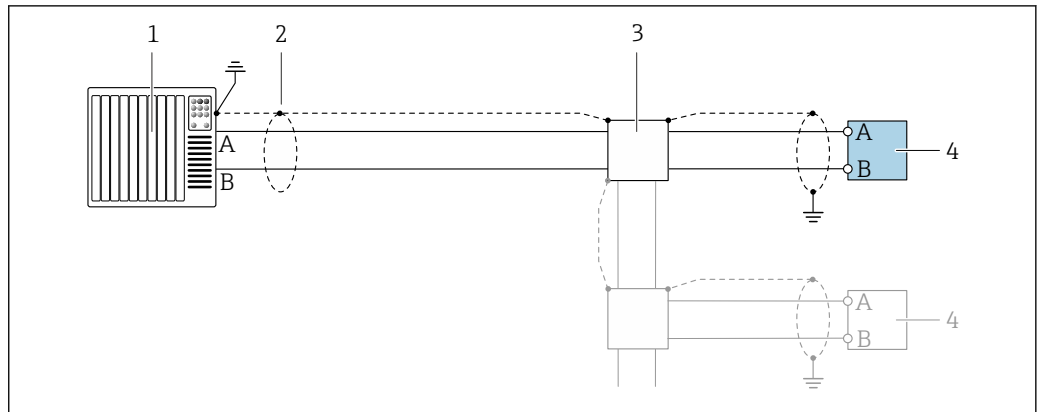

A0028765

12 Connection example for Modbus RS485, non-hazardous area and Zone 2; Class I, Division 2

- 1 Control system (e.g. PLC)
- 2 Cable shield provided at one end. The cable shield must be grounded at both ends to comply with EMC requirements; observe cable specifications
- 3 Distribution box
- 4 Transmitter

Current output 4-20 mA

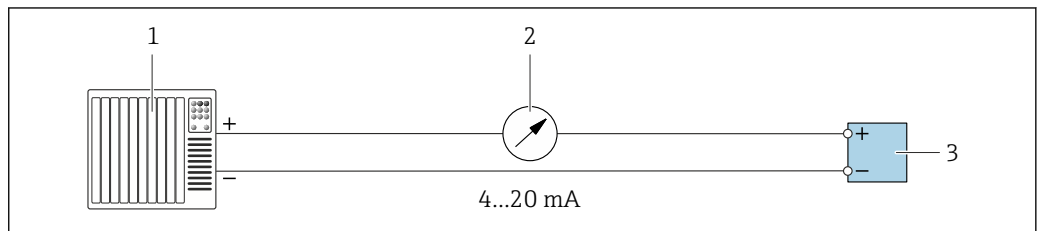

A0028758

13 Connection example for 4-20 mA current output (active)

- 1 Automation system with current input (e.g. PLC)
- 2 Analog display unit: observe maximum load → 16
- 3 Transmitter

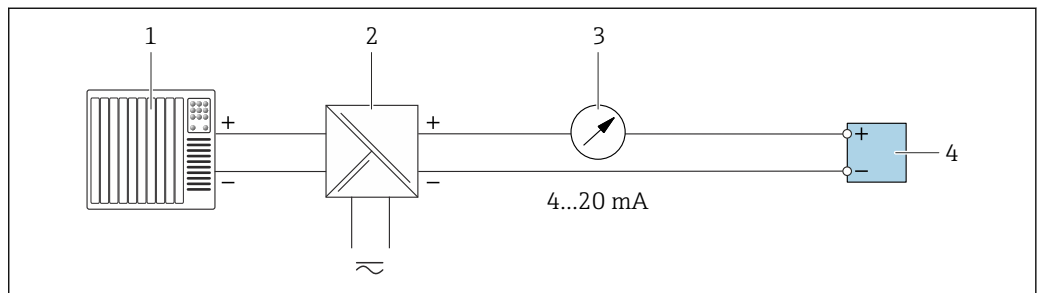

A0028759

14 Connection example for 4-20 mA current output (passive)

- 1 Automation system with current input (e.g. PLC)
- 2 Active barrier for power supply (e.g. RN221N)
- 3 Analog display unit: observe maximum load → 16
- 4 Transmitter

## Pulse/frequency output

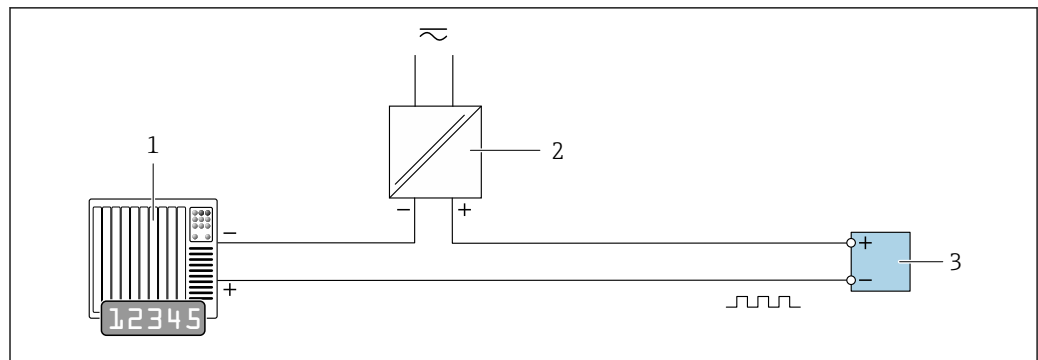

A0028761

15 Connection example for pulse/frequency output (passive)

- 1 Automation system with pulse/frequency input (e.g. PLC with 10 k $\Omega$  pull-up or pull-down resistor)
- 2 Power supply
- 3 Transmitter: observe input values → 19

## Switch output

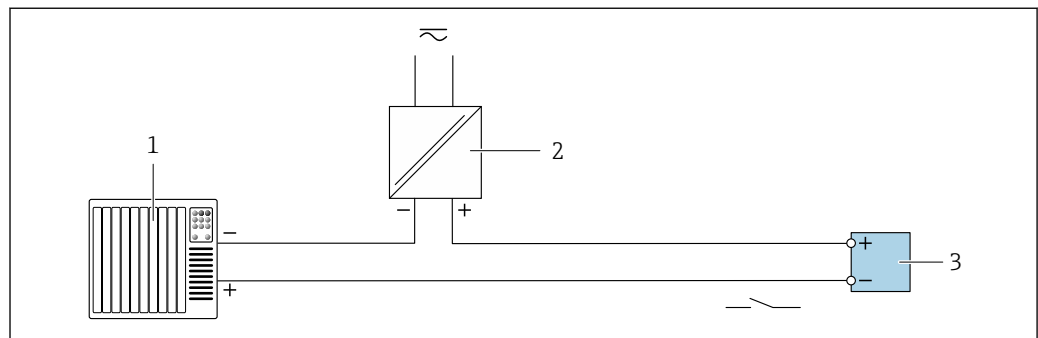

A0028760

16 Connection example for switch output (passive)

- 1 Automation system with switch input (e.g. PLC with a 10 k $\Omega$  pull-up or pull-down resistor)
- 2 Power supply
- 3 Transmitter: observe input values → 19

## Double pulse output

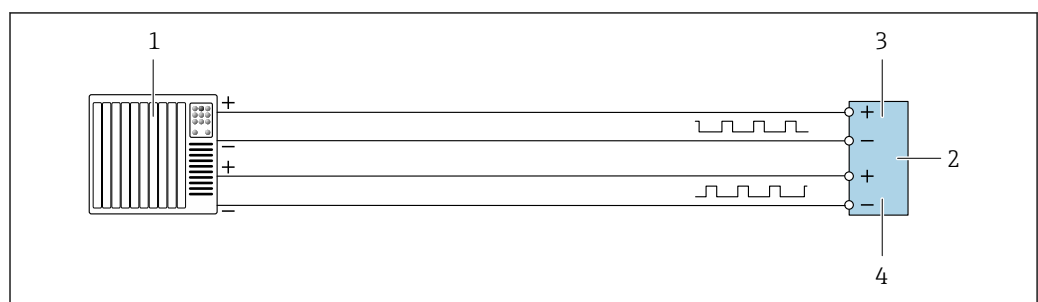

A0029280

17 Connection example for double pulse output (active)

- 1 Automation system with double pulse input (e.g. PLC)
- 2 Transmitter: observe input values → 21
- 3 Double pulse output
- 4 Double pulse output (slave), phase-shifted



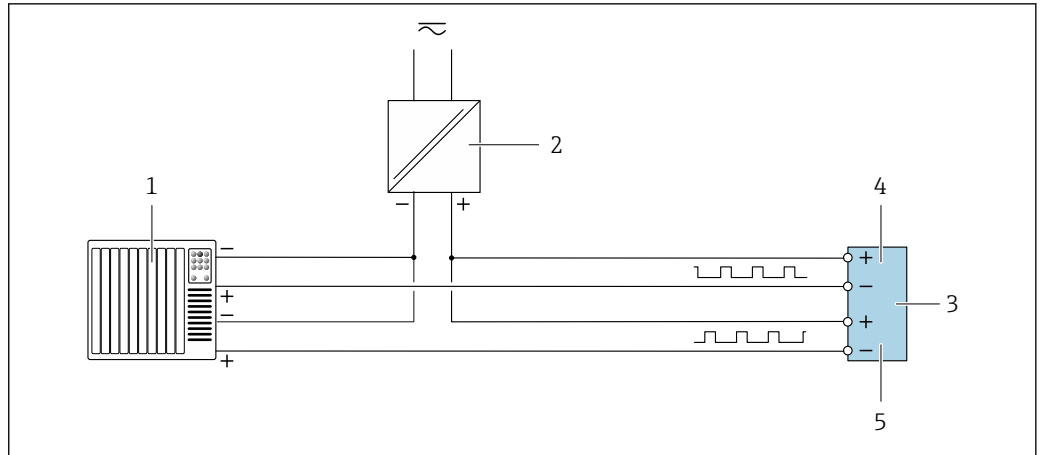

A0029279

18 Connection example for double pulse output (passive)

- 1 Automation system with double pulse input (e.g. PLC with a 10 kΩ pull-up or pull-down resistor)
- 2 Power supply
- 3 Transmitter: observe input values → 21
- 4 Double pulse output
- 5 Double pulse output (slave), phase-shifted

Relay output

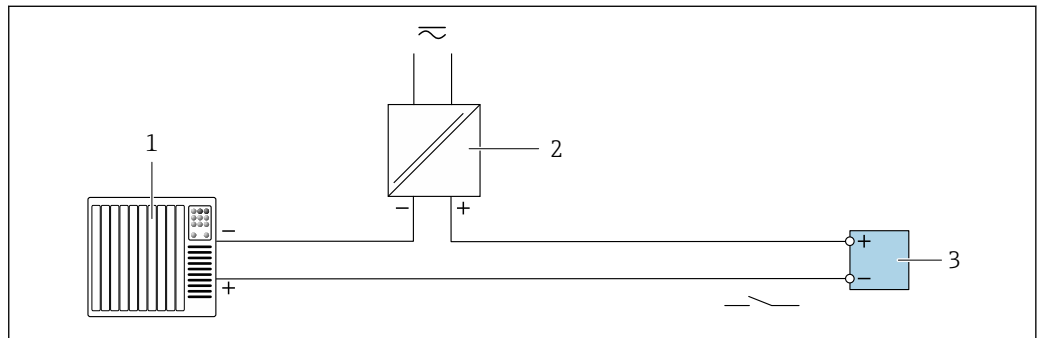

A0028760

19 Connection example for relay output (passive)

- 1 Automation system with relay input (e.g. PLC)
- 2 Power supply
- 3 Transmitter: observe input values → 21

Current input

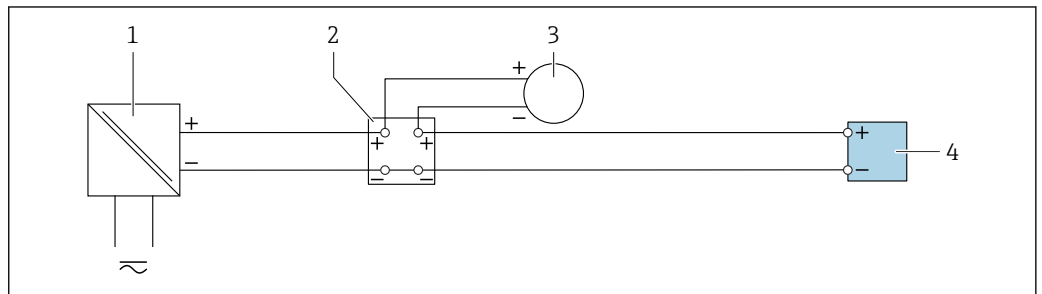

A0028915

20 Connection example for 4 to 20 mA current input

- 1 Power supply
- 2 Terminal box
- 3 External measuring device (to read in pressure or temperature, for instance)
- 4 Transmitter

Status input

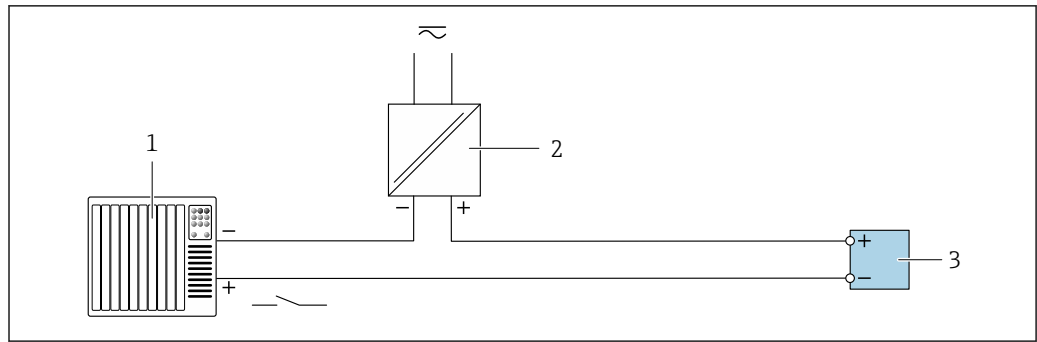

A0028764

21 Connection example for status input

- 1 Automation system with status output (e.g. PLC)
- 2 Power supply
- 3 Transmitter

Potential equalization

Requirements

For potential equalization:

- Pay attention to in-house grounding concepts
- Take account of operating conditions like the pipe material and grounding
- Connect the medium, sensor and transmitter to the same electrical potential
- Use a ground cable with a minimum cross-section of 6 mm<sup>2</sup> (0.0093 in<sup>2</sup>) and a cable lug for potential equalization connections

For devices intended for use in hazardous locations, please observe the guidelines in the Ex documentation (XA).

Terminals

Spring-loaded terminals: Suitable for strands and strands with ferrules.  
 Conductor cross-section 0.2 to 2.5 mm<sup>2</sup> (24 to 12 AWG).

Cable entries

- Cable gland: M20 × 1.5 with cable Ø 6 to 12 mm (0.24 to 0.47 in)
- Thread for cable entry:
  - NPT ½"
  - G ½"
  - M20
- Device plug for digital communication: M12  
 Only available for certain device versions → 34.

Pin assignment, device plug

FOUNDATION Fieldbus

Pin	Assignment		Coding	Plug/socket
	Signal	Grounding		
1	+	Signal +	A	Plug
2	-	Signal -		
3		Grounding		
4		Not assigned		

PROFIBUS PA

Pin	Assignment		Coding	Plug/socket
	Signal	Grounding		
1	+	PROFIBUS PA +	A	Plug
2		Grounding		
3	-	PROFIBUS PA -		
4		Not assigned		



Recommended plug:

- Binder, series 713, part no. 99 1430 814 04
- Phoenix, part no. 1413934 SACC-FS-4QO SH PBPA SCO

**PROFINET**

<p style="text-align: right; font-size: small;">A0032047</p>	Pin		Assignment	
	1	+	TD +	
	2	+	RD +	
	3	-	TD -	
	4	-	RD -	
	Coding		Plug/socket	
D		Socket		



Recommended plug:

- Binder, series 825, part no. 99 3729 810 04
- Phoenix, part no. 1543223 SACC-M12MSD-4Q

**PROFINET with Ethernet-APL**

	Pin		Assignment		Coding	Plug/socket
	1	-	APL signal -			
	2	+	APL signal +			
	3		Cable shield <sup>1</sup>			
	4		Not assigned			
	Metal plug housing		Cable shield			
<sup>1</sup> If a cable shield is used						



Recommended plug:

- Binder, series 713, part no. 99 1430 814 04
- Phoenix, part no. 1413934 SACC-FS-4QO SH PBPA SCO

**EtherNet/IP**

<p style="text-align: right; font-size: small;">A0032047</p>	Pin		Assignment	
	1	+	Tx	
	2	+	Rx	
	3	-	Tx	
	4	-	Rx	
	Coding		Plug/socket	
D		Socket		



Recommended plug:

- Binder, series 763, part no. 99 3729 810 04
- Phoenix, part no. 1543223 SACC-M12MSD-4Q

**Service interface**

Order code for "Accessories mounted", option **NB**: Adapter RJ45 M12 (service interface)

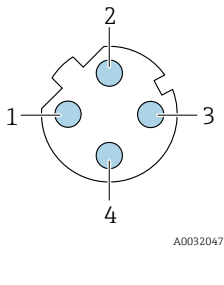
	Pin		Assignment	
	1	+	Tx	
	2	+	Rx	
	3	-	Tx	
	4	-	Rx	
	Coding		Plug/socket	
D		Socket		



Recommended plug:

- Binder, series 763, part no. 99 3729 810 04
- Phoenix, part no. 1543223 SACC-M12MSD-4Q

**Cable specification****Permitted temperature range**

- The installation guidelines that apply in the country of installation must be observed.
- The cables must be suitable for the minimum and maximum temperatures to be expected.

**Power supply cable (incl. conductor for the inner ground terminal)**

Standard installation cable is sufficient.

**Protective grounding cable for the outer ground terminal**

Conductor cross-section <math>< 2.1 \text{ mm}^2</math> (14 AWG)

The use of a cable lug enables the connection of larger cross-sections.

The grounding impedance must be less than 2  $\Omega$ .

**Signal cable**

*Current output 4 to 20 mA HART*

A shielded cable is recommended. Observe grounding concept of the plant.

**PROFIBUS PA**

Twisted, shielded two-wire cable. Cable type A is recommended .



For further information on planning and installing PROFIBUS networks see:

- Operating Instructions "PROFIBUS DP/PA: Guidelines for planning and commissioning" (BA00034S)
- PNO Directive 2.092 "PROFIBUS PA User and Installation Guideline"
- IEC 61158-2 (MBP)

**PROFIBUS DP**

The IEC 61158 standard specifies two types of cable (A and B) for the bus line which can be used for every transmission rate. Cable type A is recommended.

<b>Cable type</b>	A
<b>Characteristic impedance</b>	135 to 165 $\Omega$ at a measuring frequency of 3 to 20 MHz
<b>Cable capacitance</b>	<math>< 30 \text{ pF/m}</math>
<b>Wire cross-section</b>	> 0.34 $\text{mm}^2$ (22 AWG)
<b>Cable type</b>	Twisted pairs
<b>Loop resistance</b>	$\leq 110 \text{ } \Omega/\text{km}$

<b>Signal damping</b>	Max. 9 dB over the entire length of the cable cross-section
<b>Shield</b>	Copper braided shielding or braided shielding with foil shield. When grounding the cable shield, observe the grounding concept of the plant.



For further information on planning and installing PROFIBUS networks see:

- Operating Instructions "PROFIBUS DP/PA: Guidelines for planning and commissioning" (BA00034S)
- PNO Directive 2.092 "PROFIBUS PA User and Installation Guideline"
- IEC 61158-2 (MBP)

*EtherNet/IP*

The standard ANSI/TIA/EIA-568-B.2 Annex specifies CAT 5 as the minimum category for a cable used for EtherNet/IP. CAT 5e and CAT 6 are recommended.



For more information on planning and installing EtherNet/IP networks, please refer to the "Media Planning and Installation Manual. EtherNet/IP" of ODVA Organization

*PROFINET*

Standard IEC 61156-6 specifies CAT 5 as the minimum category for a cable used for PROFINET. CAT 5e and CAT 6 are recommended.



For more information on planning and installing PROFINET networks, see: "PROFINET Cabling and Interconnection Technology", Guideline for PROFINET

*PROFINET with Ethernet-APL*

The reference cable type for APL segments is fieldbus cable type A, MAU type 1 and 3 (specified in IEC 61158-2). This cable meets the requirements for intrinsically safe applications according to IEC TS 60079-47 and can also be used in non-intrinsically safe applications.

<b>Cable type</b>	A
<b>Cable capacitance</b>	45 to 200 nF/km
<b>Loop resistance</b>	15 to 150 Ω/km
<b>Cable inductance</b>	0.4 to 1 mH/km

Further details are provided in the Ethernet-APL Engineering Guideline (<https://www.ethernet-apl.org>).

*FOUNDATION Fieldbus*

Twisted, shielded two-wire cable.



For further information on planning and installing FOUNDATION Fieldbus networks see:

- Operating Instructions for "FOUNDATION Fieldbus Overview" (BA00013S)
- FOUNDATION Fieldbus Guideline
- IEC 61158-2 (MBP)

*Modbus RS485*

The EIA/TIA-485 standard specifies two types of cable (A and B) for the bus line which can be used for every transmission rate. Cable type A is recommended.

<b>Cable type</b>	A
<b>Characteristic impedance</b>	135 to 165 Ω at a measuring frequency of 3 to 20 MHz
<b>Cable capacitance</b>	< 30 pF/m
<b>Wire cross-section</b>	> 0.34 mm <sup>2</sup> (22 AWG)
<b>Cable type</b>	Twisted pairs
<b>Loop resistance</b>	≤110 Ω/km

<b>Signal damping</b>	Max. 9 dB over the entire length of the cable cross-section
<b>Shield</b>	Copper braided shielding or braided shielding with foil shield. When grounding the cable shield, observe the grounding concept of the plant.

#### *Current output 0/4 to 20 mA*

- Standard installation cable is sufficient
- For custody transfer measurement, use a shielded cable: tin-plated copper braid, optical cover  $\geq 85\%$

#### *Pulse /frequency /switch output*

- Standard installation cable is sufficient
- For custody transfer measurement, use a shielded cable: tin-plated copper braid, optical cover  $\geq 85\%$

#### *Double pulse output*

- Standard installation cable is sufficient
- For custody transfer measurement, use a shielded cable: tin-plated copper braid, optical cover  $\geq 85\%$

#### *Relay output*

Standard installation cable is sufficient.

#### *Current input 0/4 to 20 mA*

- Standard installation cable is sufficient
- For custody transfer measurement, use a shielded cable: tin-plated copper braid, optical cover  $\geq 85\%$

#### *Status input*

- Standard installation cable is sufficient
- For custody transfer measurement, use a shielded cable: tin-plated copper braid, optical cover  $\geq 85\%$

### **Connecting cable for transmitter - remote display and operating module DKX001**

#### *Standard cable*

A standard cable can be used as the connecting cable.

<b>Standard cable</b>	4 cores (2 pairs); pair-stranded with common shield
<b>Shielding</b>	Tin-plated copper-braid, optical cover $\geq 85\%$
<b>Capacitance: core/shield</b>	Maximum 1 000 nF for Zone 1; Class I, Division 1
<b>L/R</b>	Maximum 24 $\mu\text{H}/\Omega$ for Zone 1; Class I, Division 1
<b>Cable length</b>	Maximum 300 m (1 000 ft), see the following table

Cross-section	Cable length for use in:
	<ul style="list-style-type: none"> <li>■ Non-hazardous area</li> <li>■ Hazardous area: Zone 2; Class I, Division 2</li> <li>■ Hazardous area: Zone 1; Class I, Division 1</li> </ul>
0.34 mm <sup>2</sup> (22 AWG)	80 m (270 ft)
0.50 mm <sup>2</sup> (20 AWG)	120 m (400 ft)
0.75 mm <sup>2</sup> (18 AWG)	180 m (600 ft)
1.00 mm <sup>2</sup> (17 AWG)	240 m (800 ft)
1.50 mm <sup>2</sup> (15 AWG)	300 m (1 000 ft)

*Optionally available connecting cable*

<b>Standard cable</b>	2 × 2 × 0.34 mm <sup>2</sup> (22 AWG) PVC cable <sup>1)</sup> with common shield (2 pairs, pair-stranded)
<b>Flame resistance</b>	According to DIN EN 60332-1-2
<b>Oil-resistance</b>	According to DIN EN 60811-2-1
<b>Shielding</b>	Tin-plated copper-braid, optical cover ≥ 85 %
<b>Capacitance: core/shield</b>	≤200 pF/m
<b>L/R</b>	≤24 μH/Ω
<b>Available cable length</b>	10 m (35 ft)
<b>Operating temperature</b>	When mounted in a fixed position: -50 to +105 °C (-58 to +221 °F); when cable can move freely: -25 to +105 °C (-13 to +221 °F)

1) UV radiation can impair the cable outer sheath. Protect the cable from direct sunshine where possible.

**Overvoltage protection**

<b>Mains voltage fluctuations</b>	→ ☰ 35
<b>Overvoltage category</b>	Overvoltage category II
<b>Short-term, temporary overvoltage</b>	Up to 1200 V between cable and ground, for max. 5 s
<b>Long-term, temporary overvoltage</b>	Up to 500 V between cable and ground

## Performance characteristics

**Reference operating conditions**

- Error limits based on ISO 11631
- Water with +15 to +45 °C (+59 to +113 °F) at 2 to 6 bar (29 to 87 psi)
- Specifications as per calibration protocol
- Accuracy based on accredited calibration rigs that are traced to ISO 17025.

 To obtain measured errors, use the *Applicator* sizing tool → ☰ 130

**Maximum measured error**

o.r. = of reading; 1 g/cm<sup>3</sup> = 1 kg/l; T = medium temperature

**Base accuracy**

 Design fundamentals → ☰ 55

*Mass flow and volume flow (liquids)*

- ±0.05 % o.r. (optional for mass flow: PremiumCal; order code for "Calibration flow", option D)
- ±0.10 % o.r. (standard)

*Mass flow (gases)*

±0.25 % o.r.

*Mass flow (cryogenic liquids and gases under -100 °C (-148 °F))*

±0.35 % o.r. (order code for "Measuring tube material", option LA)

*Density (liquids)*

Under reference conditions	Standard density calibration	Wide-range Density specification <sup>1) 2)</sup>
[g/cm <sup>3</sup> ]	[g/cm <sup>3</sup> ]	[g/cm <sup>3</sup> ]
±0.0005	±0.0005	±0.001

1) Valid range for special density calibration: 0 to 2 g/cm<sup>3</sup>, +5 to +80 °C (+41 to +176 °F)

2) order code for "Application package", option EE "Special density"

*Density (cryogenic liquids and gases under -100 °C (-148 °F))*

±0.05 g/cm<sup>3</sup> (order code for "Measuring tube material", option LA)

*Temperature*

±0.5 °C ± 0.005 · T °C (±0.9 °F ± 0.003 · (T - 32) °F)

**Zero point stability**

DN		Zero point stability	
[mm]	[in]	[kg/h]	[lb/min]
8	<sup>3</sup> / <sub>8</sub>	0.030	0.001
15	<sup>1</sup> / <sub>2</sub>	0.200	0.007
25	1	0.540	0.019
40	1 <sup>1</sup> / <sub>2</sub>	2.25	0.083
50	2	3.50	0.129
80	3	9.0	0.330
100	4	14.0	0.514
150	6	32.0	1.17
250	10	88.0	3.23

*High-temperature version: order code for "Measuring tube material", option TS, TT, TU*

DN		Zero point stability	
[mm]	[in]	[kg/h]	[lb/min]
15	<sup>1</sup> / <sub>2</sub>	0.3	0.011
25	1	1.8	0.0662
50	2	7	0.2573
80	3	18	0.6615
100	4	21	0.7718
150	6	48	1.764
250	10	132	4.851

For devices with low-temperature version, order code for "Measuring tube mat., wetted surface", option LA, please note the following:

**NOTICE**

**Zero point confirmation and zero adjustment are difficult to carry out in the field due to the vaporization of the cryogenic liquid.**

- ▶ As a general rule, the factory-set zero point should not be changed. Please ensure that the medium is in the liquid phase if a zero adjustment is to be carried out.



**Flow values**

Flow values as turndown parameters depending on the nominal diameter.

*SI units*

DN	1:1	1:10	1:20	1:50	1:100	1:500
[mm]	[kg/h]	[kg/h]	[kg/h]	[kg/h]	[kg/h]	[kg/h]
8	2 000	200	100	40	20	4
15	6 500	650	325	130	65	13
25	18 000	1 800	900	360	180	36
40	45 000	4 500	2 250	900	450	90
50	70 000	7 000	3 500	1 400	700	140
80	180 000	18 000	9 000	3 600	1 800	360
100	350 000	35 000	17 500	7 000	3 500	700
150	800 000	80 000	40 000	16 000	8 000	1 600
250	2 200 000	220 000	110 000	44 000	22 000	4 400

*US units*

DN	1:1	1:10	1:20	1:50	1:100	1:500
[inch]	[lb/min]	[lb/min]	[lb/min]	[lb/min]	[lb/min]	[lb/min]
$\frac{3}{8}$	73.50	7.350	3.675	1.470	0.735	0.147
$\frac{1}{2}$	238.9	23.89	11.95	4.778	2.389	0.478
1	661.5	66.15	33.08	13.23	6.615	1.323
1½	1 654	165.4	82.70	33.08	16.54	3.308
2	2 573	257.3	128.7	51.46	25.73	5.146
3	6 615	661.5	330.8	132.3	66.15	13.23
4	12 860	1 286	643.0	257.2	128.6	25.72
6	29 400	2 940	1 470	588	294	58.80
10	80 850	8 085	4 043	1 617	808.5	161.7

**Accuracy of outputs**

The outputs have the following base accuracy specifications.

*Current output*

<b>Accuracy</b>	±5 µA
-----------------	-------

*Pulse/frequency output*

o.r. = of reading

<b>Accuracy</b>	Max. ±50 ppm o.r. (over the entire ambient temperature range)
-----------------	---

**Repeatability**

o.r. = of reading; 1 g/cm<sup>3</sup> = 1 kg/l; T = medium temperature

**Base repeatability**

 Design fundamentals →  55

*Mass flow and volume flow (liquids)*

±0.025 % o.r. (PremiumCal)  
 ±0.05 % o.r.

*Mass flow (gases)*

±0.20 % o.r.

*Mass flow (cryogenic liquids and gases under -100 °C (-148 °F))*

±0.175 % o.r. (order code for "Measuring tube material", option LA)

*Density (liquids)*

±0.00025 g/cm<sup>3</sup>

*Density (cryogenic liquids and gases under -100 °C (-148 °F))*

±0.025 g/cm<sup>3</sup> (order code for "Measuring tube material", option LA)

*Temperature*

±0.25 °C ± 0.0025 · T °C (±0.45 °F ± 0.0015 · (T-32) °F)

**Response time**

The response time depends on the configuration (damping).

**Influence of ambient temperature****Current output**

<b>Temperature coefficient</b>	Max. 1 µA/°C
--------------------------------	--------------

**Pulse/frequency output**

<b>Temperature coefficient</b>	No additional effect. Included in accuracy.
--------------------------------	---

**Influence of medium temperature****Mass flow and volume flow**

o.f.s. = of full scale value

If there is a difference between the temperature during zero adjustment and the process temperature, the additional measured error of the sensors is typically ±0.0002 %o.f.s./°C (±0.0001 % o.f.s./°F).

The influence is reduced when the zero adjustment is performed at process temperature.

**Density**

If there is a difference between the density calibration temperature and the process temperature, the measured error of the sensors is typically ±0.00005 g/cm<sup>3</sup>/°C (±0.000025 g/cm<sup>3</sup>/°F). Field density adjustment is possible.

Can also be used for order code for "Measuring tube material", option LA up to -100 °C (-148 °F).

**Wide-range density specification (special density calibration)**

If the process temperature is outside the valid range (→ 51) the measured error is ±0.00005 g/cm<sup>3</sup> /°C (±0.000025 g/cm<sup>3</sup> /°F)

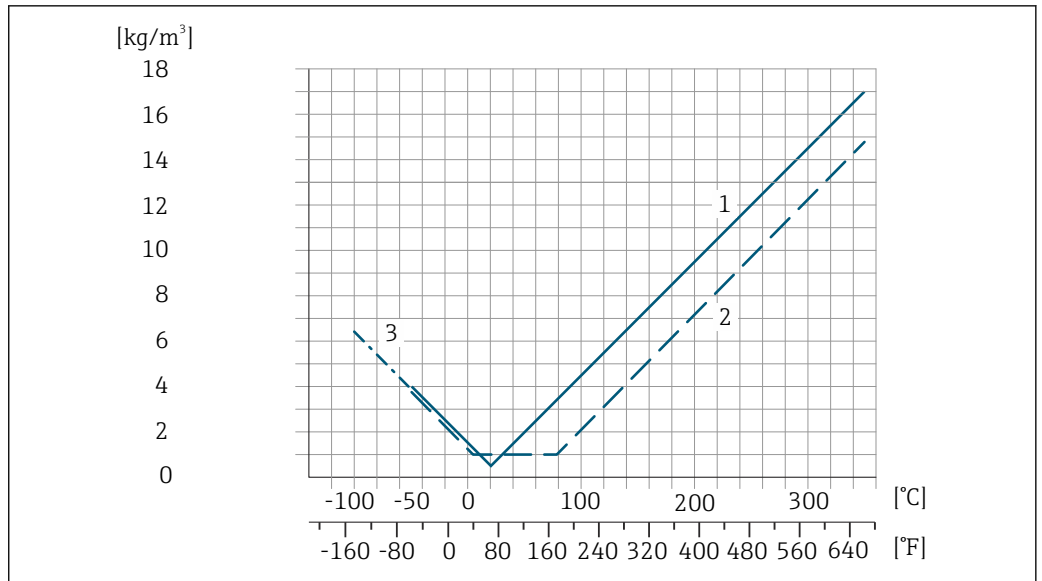

A0027453

- 1 Field density adjustment, for example at +20 °C (+68 °F)
- 2 Special density calibration
- 3 Applicable for the order code for "Measuring tube material", option LA

**Temperature**

$$\pm 0.005 \cdot T \text{ °C } (\pm 0.005 \cdot (T - 32) \text{ °F})$$

**Influence of medium pressure**

The tables below show the effect that a difference in pressure between the calibration pressure and the process pressure has on the accuracy in the case of the mass flow and density.

o.r. = of reading



It is possible to compensate for the effect by:

- Reading in the current pressure measured value via the current input or a digital input.
- Specifying a fixed value for the pressure in the device parameters.



Operating Instructions → 131.

DN		[% o.r./bar]	[% o.r./psi]
[mm]	[in]		
8	3/8	no influence	
15	1/2	-0.002	-0.0001
25	1	no influence	
40	1 1/2	-0.003	-0.0002
50	2	-0.008	-0.0006
80	3	-0.009	-0.0006
100	4	-0.007	-0.0005
150	6	-0.009	-0.0006
250	10	-0.009	-0.0006

**Design fundamentals**

o.r. = of reading, o.f.s. = of full scale value

BaseAccu = base accuracy in % o.r., BaseRepeat = base repeatability in % o.r.

MeasValue = measured value; ZeroPoint = zero point stability

Calculation of the maximum measured error as a function of the flow rate

Flow rate	Maximum measured error in % o.r.
$\geq \frac{\text{ZeroPoint}}{\text{BaseAccu}} \cdot 100$ <small>A0021332</small>	$\pm \text{BaseAccu}$ <small>A0021339</small>
$< \frac{\text{ZeroPoint}}{\text{BaseAccu}} \cdot 100$ <small>A0021333</small>	$\pm \frac{\text{ZeroPoint}}{\text{MeasValue}} \cdot 100$ <small>A0021334</small>

Calculation of the maximum repeatability as a function of the flow rate

Flow rate	Maximum repeatability in % o.r.
$\geq \frac{1/2 \cdot \text{ZeroPoint}}{\text{BaseRepeat}} \cdot 100$ <small>A0021335</small>	$\pm \text{BaseRepeat}$ <small>A0021340</small>
$< \frac{1/2 \cdot \text{ZeroPoint}}{\text{BaseRepeat}} \cdot 100$ <small>A0021336</small>	$\pm 1/2 \cdot \frac{\text{ZeroPoint}}{\text{MeasValue}} \cdot 100$ <small>A0021337</small>

Example of maximum measured error

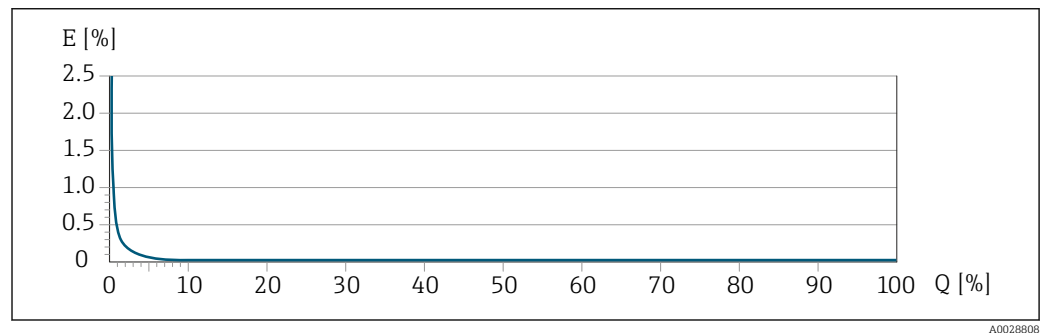

*E* Maximum measured error in % o.r. (example with PremiumCal)  
*Q* Flow rate in % of maximum full scale value

## Installation

### Mounting location

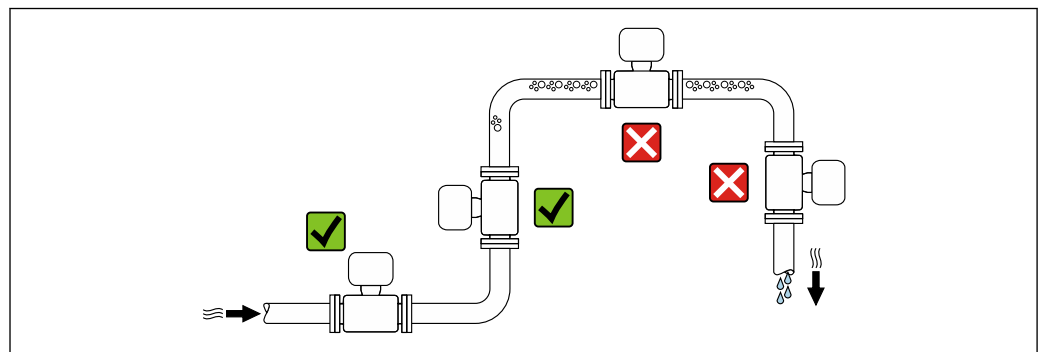

To prevent measuring errors arising from accumulation of gas bubbles in the measuring pipe, avoid the following mounting locations in the piping:

- Highest point of a pipeline.
- Directly upstream of a free pipe outlet in a down pipe.

**Installation in down pipes**

However, the following installation suggestion allows for installation in an open vertical pipeline. Pipe restrictions or the use of an orifice with a smaller cross-section than the nominal diameter prevent the sensor running empty while measurement is in progress.

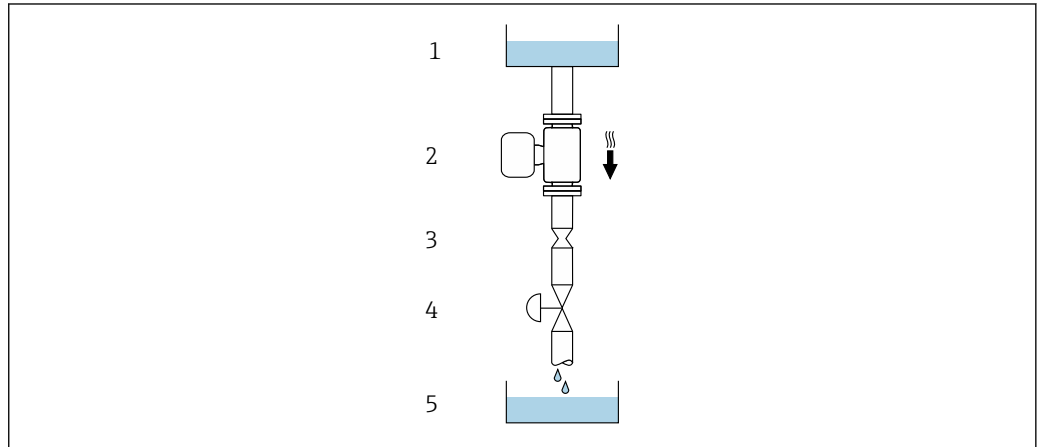

A0028773

☑ 22 Installation in a down pipe (e.g. for batching applications)





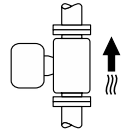
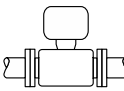

- 1 Supply tank
- 2 Sensor
- 3 Orifice plate, pipe restriction
- 4 Valve
- 5 Batching tank

DN		Ø orifice plate, pipe restriction	
[mm]	[in]	[mm]	[in]
8	3/8	6	0.24
15	1/2	10	0.40
25	1	14	0.55
40	1 1/2	22	0.87
50	2	28	1.10
80	3	50	1.97
100	4	65	2.60
150	6	90	3.54
250	10	150	5.91

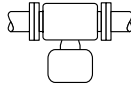
**Orientation**

The direction of the arrow on the sensor nameplate helps you to install the sensor according to the flow direction (direction of medium flow through the piping).

Orientation		Recommendation
<b>A</b>	Vertical orientation	 <small>A0015591</small> ☑☑ <sup>1)</sup>
<b>B</b>	Horizontal orientation, transmitter at top	 <small>A0015589</small> ☑☑ <sup>2)</sup> Exception: → ☑ 23, ☑ 58

Orientation		Recommendation
C	Horizontal orientation, transmitter at bottom  A0015590	  <sup>3)</sup> Exception: →  , 
D	Horizontal orientation, transmitter at side  A0015592	

- 1) This orientation is recommended to ensure self-draining.
- 2) Applications with low process temperatures may reduce the ambient temperature. To maintain the minimum ambient temperature for the transmitter, this orientation is recommended.
- 3) Applications with high process temperatures may increase the ambient temperature. To maintain the maximum ambient temperature for the transmitter, this orientation is recommended.

If a sensor is installed horizontally with a curved measuring tube, match the position of the sensor to the fluid properties.

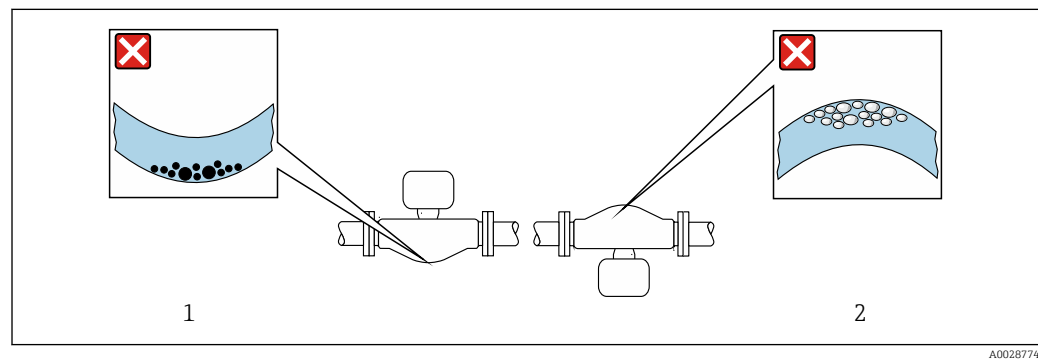

 23 Orientation of sensor with curved measuring tube

- 1 Avoid this orientation for fluids with entrained solids: Risk of solids accumulating.
- 2 Avoid this orientation for outgassing fluids: Risk of gas accumulating.

## Inlet and outlet runs



No special precautions need to be taken for fittings which create turbulence, such as valves, elbows or T-pieces, as long as no cavitation occurs →  68.

## Special mounting instructions

### Drainability

When installed vertically, the measuring tubes can be drained completely and protected against buildup.

### Hygienic compatibility

-  When installing in hygienic applications, please refer to the information in the "Certificates and approvals/hygienic compatibility" section →  123
- In the case of measuring devices with the order code for "Housing", option B "Stainless, hygienic", to seal the connection compartment cover, screw it closed finger-tight and tighten it by another 45° (corresponds to 15 Nm).

### Rupture disk

Process-related information: →  68.

### WARNING

#### Danger from medium escaping!

Medium escaping under pressure can cause injury or material damage.

- ▶ Take precautions to prevent danger to persons and damage if the rupture disk is actuated.
- ▶ Observe the information on the rupture disk sticker.
- ▶ Make sure that the function and operation of the rupture disk is not impeded through the installation of the device.
- ▶ Do not use a heating jacket.
- ▶ Do not remove or damage the rupture disk.

The position of the rupture disk is indicated by a sticker affixed beside it.

The transportation guard must be removed.

The existing connecting nozzles are not intended for the purpose of rinsing or pressure monitoring, but instead serve as the mounting location for the rupture disk.

In the event of a failure of the rupture disk, a drain device can be screwed onto the female thread of the rupture disk in order to drain off any escaping medium.

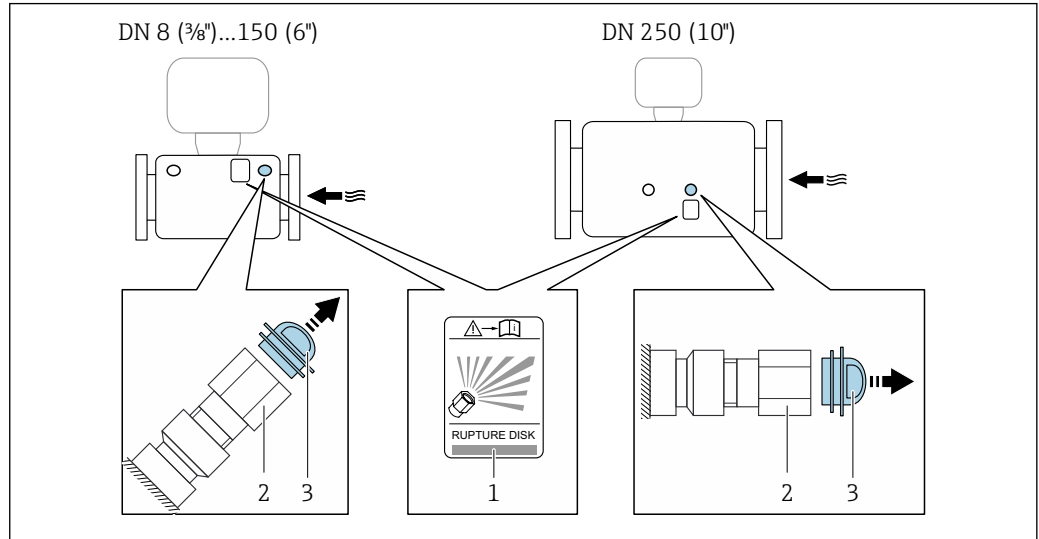

- 1 Rupture disk label
- 2 Rupture disk with 1/2" NPT female thread and 1" width across flats
- 3 Transport protection

For information on the dimensions, see the "Mechanical construction" section (accessories).

## Environment

<b>Ambient temperature range</b>	<b>Measuring device</b>	<ul style="list-style-type: none"> <li>■ -40 to +60 °C (-40 to +140 °F)</li> <li>■ Order code for "Test, certificate", option JP: -50 to +60 °C (-58 to +140 °F)</li> </ul>
	<b>Readability of the local display</b>	-20 to +60 °C (-4 to +140 °F) The readability of the display may be impaired at temperatures outside the temperature range.

**i** Dependency of ambient temperature on medium temperature → 60



► If operating outdoors:  
Avoid direct sunlight, particularly in warm climatic regions.

**i** You can order a weather protection cover from Endress+Hauser. → 128.

<b>Storage temperature</b>	-50 to +80 °C (-58 to +176 °F)
----------------------------	--------------------------------

<b>Climate class</b>	DIN EN 60068-2-38 (test Z/AD)
----------------------	-------------------------------

<b>Relative humidity</b>	The device is suitable for use in outdoor and indoor areas with a relative humidity of 4 to 95%.
--------------------------	--

<b>Operating height</b>	<p>According to EN 61010-1</p> <ul style="list-style-type: none"> <li>▪ ≤ 2 000 m (6 562 ft)</li> <li>▪ &gt; 2 000 m (6 562 ft) with additional overvoltage protection (e.g. Endress+Hauser HAW Series)</li> </ul>
<b>Degree of protection</b>	<p><b>Transmitter</b></p> <ul style="list-style-type: none"> <li>▪ IP66/67, Type 4X enclosure, suitable for pollution degree 4</li> <li>▪ When the housing is open: IP20, Type 1 enclosure, suitable for pollution degree 2</li> <li>▪ Display module: IP20, Type 1 enclosure, suitable for pollution degree 2</li> </ul> <p><b>Optional</b></p> <p>Order code for "Sensor options", option CM "IP69"</p> <p><b>External WLAN antenna</b></p> <p>IP67</p>
<b>Vibration- and shock-resistance</b>	<p><b>Vibration sinusoidal, in accordance with IEC 60068-2-6</b></p> <ul style="list-style-type: none"> <li>▪ 2 to 8.4 Hz, 3.5 mm peak</li> <li>▪ 8.4 to 2 000 Hz, 1 g peak</li> </ul> <p><b>Vibration broad-band random, according to IEC 60068-2-64</b></p> <ul style="list-style-type: none"> <li>▪ 10 to 200 Hz, 0.003 g<sup>2</sup>/Hz</li> <li>▪ 200 to 2 000 Hz, 0.001 g<sup>2</sup>/Hz</li> <li>▪ Total: 1.54 g rms</li> </ul> <p><b>Shock half-sine, according to IEC 60068-2-27</b></p> <p>6 ms 30 g</p> <p><b>Rough handling shocks, according to IEC 60068-2-31</b></p>
<b>Interior cleaning</b>	<ul style="list-style-type: none"> <li>▪ Cleaning in place (CIP)</li> <li>▪ Sterilization in place (SIP)</li> </ul> <p><b>Options</b></p> <ul style="list-style-type: none"> <li>▪ Oil- and grease-free version for wetted parts, without declaration Order code for "Service", option HA</li> <li>▪ Oil- and grease-free version for wetted parts as per IEC/TR 60877-2.0 and BOC 50000810-4, with declaration Order code for "Service", option HB</li> </ul>
<b>Mechanical load</b>	<p>Transmitter housing:</p> <ul style="list-style-type: none"> <li>▪ Protect against mechanical effects, such as shock or impact</li> <li>▪ Do not use as a ladder or climbing aid</li> </ul>
<b>Electromagnetic compatibility (EMC)</b>	<ul style="list-style-type: none"> <li>▪ As per IEC/EN 61326 and NAMUR Recommendation 21 (NE 21)</li> <li>▪ Device version with PROFIBUS DP: Complies with emission limits for industry as per EN 50170 Volume 2, IEC 61784</li> </ul> <p> The following applies for PROFIBUS DP: If baud rates &gt; 1.5 Mbaud, an EMC cable entry must be used and the cable shield must continue as far as the terminal wherever possible.</p> <p> Details are provided in the Declaration of Conformity.</p> <p> This unit is not intended for use in residential environments and cannot guarantee adequate protection of the radio reception in such environments.</p>

## Process

Medium temperature range



Standard version	-50 to +150 °C (-58 to +302 °F)	Order code for "Measuring tube mat., wetted surface", option HA, SA, SB, SC
Extended temperature version	-50 to +240 °C (-58 to +464 °F)	Order code for "Measuring tube mat., wetted surface", option SD, SE, SF, TH
High-temperature version	-50 to +350 °C (-58 to +662 °F)	For nominal diameters DN 15 (½"), 25 (1"), 50 to 250 (2 to 10") Order code for "Measuring tube mat., wetted surface", option TS, TT, TU
Low-temperature version	-196 to +150 °C (-320 to +302 °F) <b>NOTICE</b> <b>Material fatigue due to excessive temperature difference!</b> ▶ Maximum temperature difference of media used: 300 K	Order code for "Measuring tube mat., wetted surface", option LA

**Dependency of ambient temperature on medium temperature**

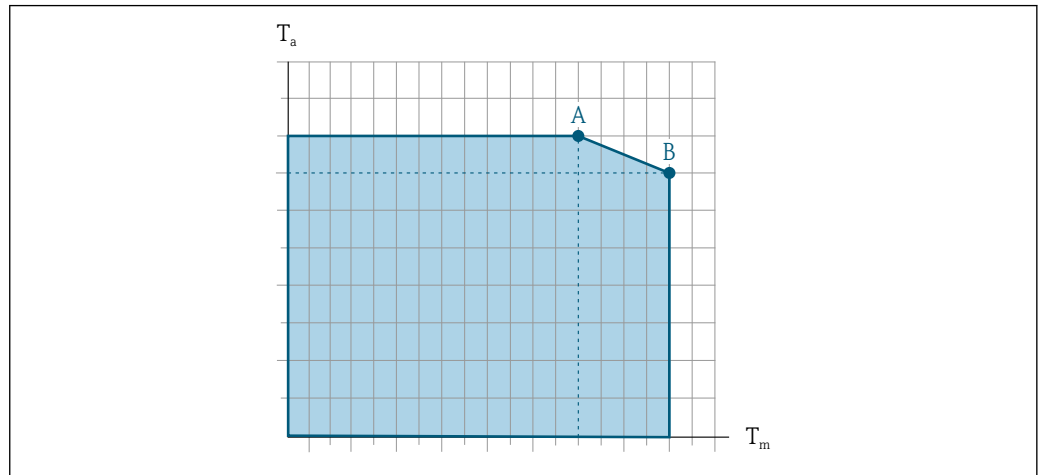

24 Exemplary representation, values in the table below.

$T_a$  Ambient temperature

$T_m$  Medium temperature

A Maximum permitted medium temperature  $T_m$  at  $T_{a,max} = 60\text{ °C}$  (140 °F); higher medium temperatures  $T_m$  require a reduction in the ambient temperature  $T_a$

B Maximum permitted ambient temperature  $T_a$  for the maximum specified medium temperature  $T_m$  of the sensor



Values for devices that are used in the hazardous area:  
Separate Ex documentation (XA) for the device → 132.

Version	Not insulated				Insulated			
	A		B		A		B	
	T <sub>a</sub>	T <sub>m</sub>	T <sub>a</sub>	T <sub>m</sub>	T <sub>a</sub>	T <sub>m</sub>	T <sub>a</sub>	T <sub>m</sub>
Standard version	60 °C (140 °F)	150 °C (302 °F)	-	-	60 °C (140 °F)	110 °C (230 °F) <sup>1)</sup>	55 °C (131 °F)	150 °C (302 °F)
Extended temperature version	60 °C (140 °F)	160 °C (320 °F) <sup>2)</sup>	55 °C (131 °F)	240 °C (464 °F)	60 °C (140 °F)	110 °C (230 °F)	50 °C (122 °F) <sup>3)</sup>	240 °C (464 °F)
High-temperature version	60 °C (140 °F)	350 °C (662 °F)	-	-	60 °C (140 °F)	350 °C (662 °F)	-	-

- 1) If the sensor is installed in such a way that the transmitter is not mounted above the sensor and free convection can occur on all sides, the maximum permitted medium temperature is: 150 °C (302 °F)
- 2) If the sensor is installed in such a way that the transmitter is not mounted above the sensor and free convection can occur on all sides, the maximum permitted medium temperature is: 240 °C (464 °F)
- 3) If the sensor is installed in such a way that the transmitter is not mounted above the sensor and free convection can occur on all sides, the maximum permitted ambient temperature is: 55 °C (131 °F)

**Density** 0 to 5 000 kg/m<sup>3</sup> (0 to 312 lb/cf)

**Pressure-temperature ratings**

The following pressure/temperature diagrams apply to all pressure-bearing parts of the device and not just the process connection. The diagrams show the maximum permissible medium pressure depending on the specific medium temperature.

-  Pressure-temperature ratings with the +151 to +240 °C (+304 to +464 °F) temperature range only for the extended temperature version of the measuring device.
- Pressure-temperature ratings with the +241 to +350 °C (+466 to +662 °F) temperature range only for the high-temperature version of the measuring device.
- Pressure-temperature ratings with the -196 to +150 °C (-320 to +302 °F) temperature range only for the low-temperature version of the measuring device.

**Flange according to EN 1092-1 (DIN 2501)**

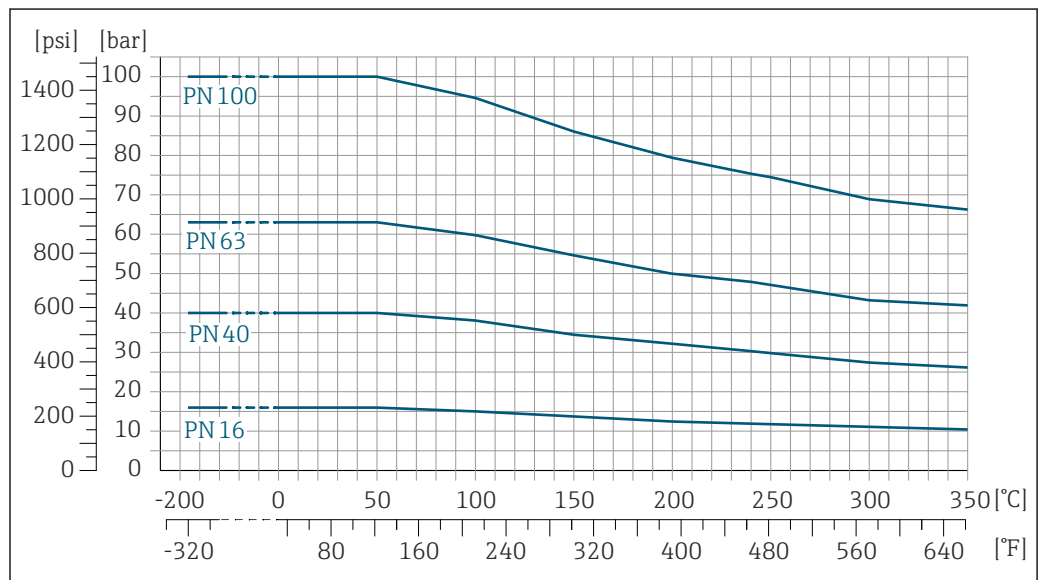

 25 With flange material 1.4404 (F316/F316L), Alloy C22

A0032852-EN

Flange according to ASME B16.5

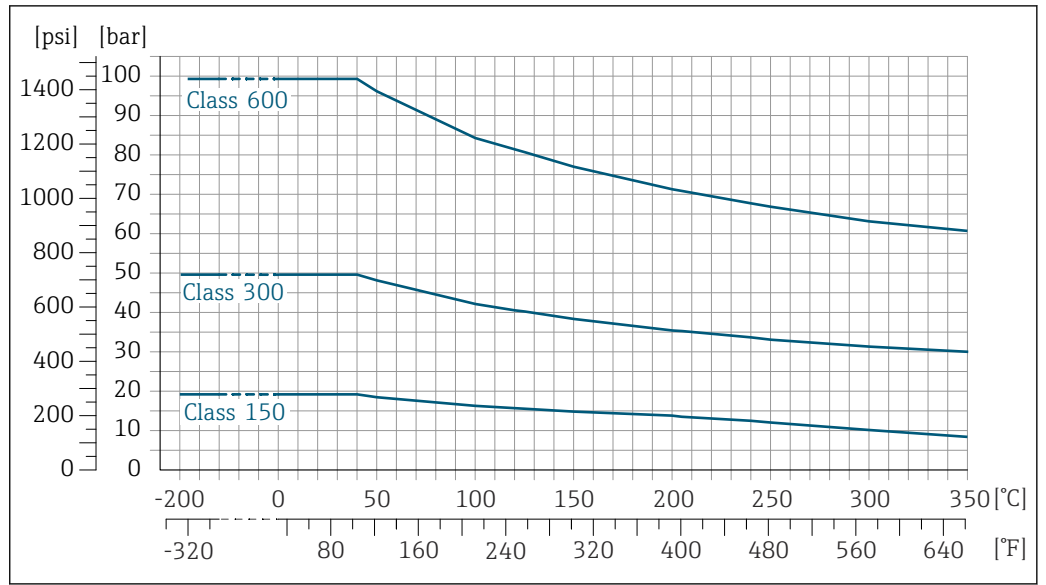

26 With flange material 1.4404 (F316/F316L)

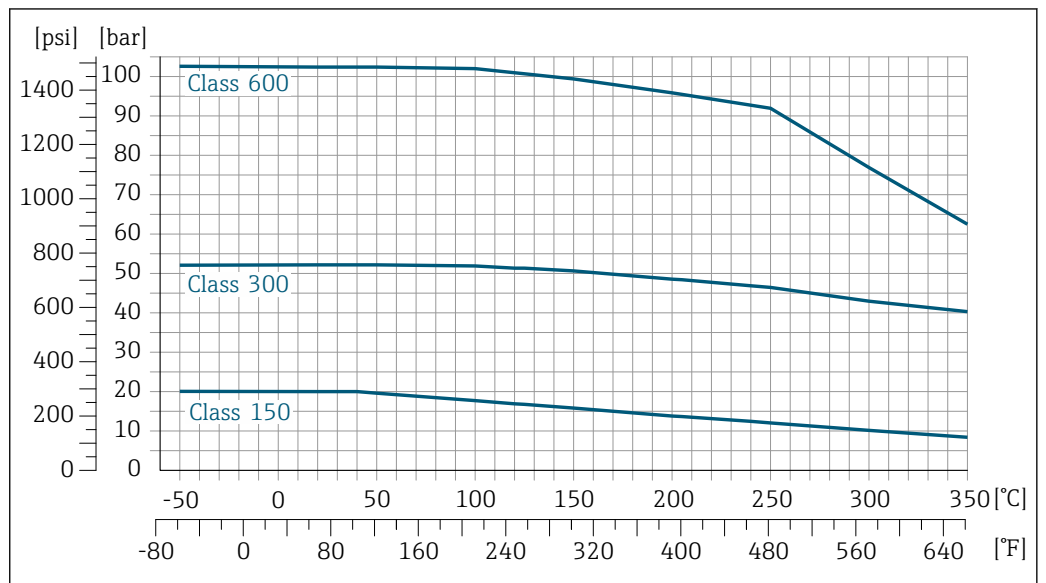

27 With flange material Alloy C22

**Flange JIS B2220**

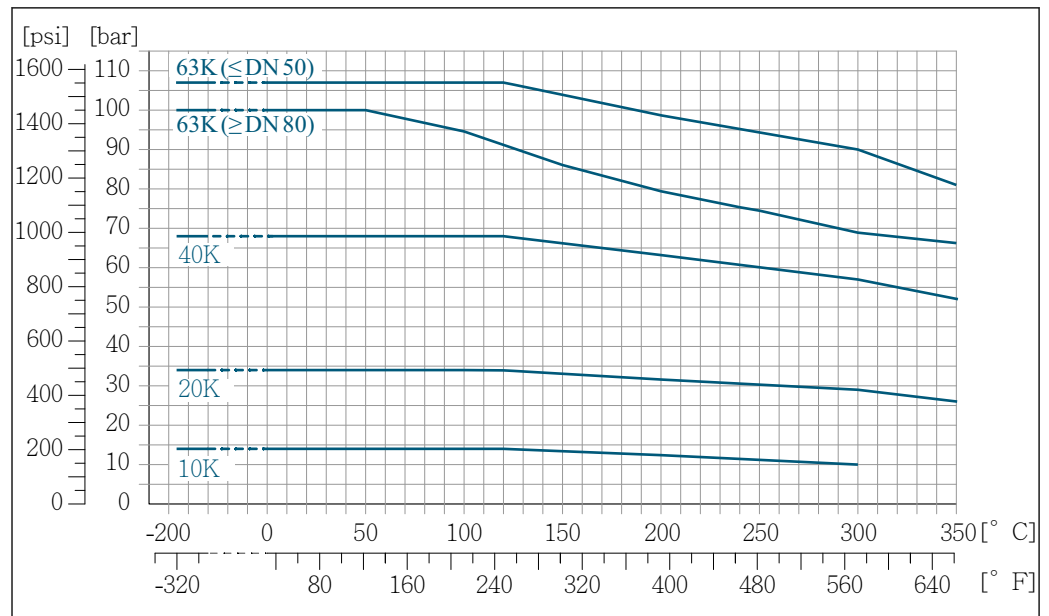

A0032851-EN

28 With flange material 1.4404 (F316/F316L), Alloy C22

**Flange DIN 11864-2 Form A**

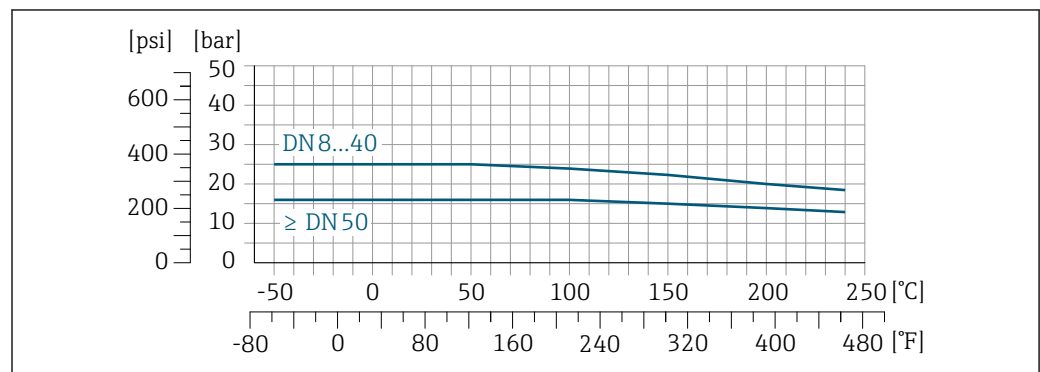

A0028782-EN

29 With connection material 1.4404 (316/316L)

**Lap joint flange according to EN 1092-1 (DIN 2501)**

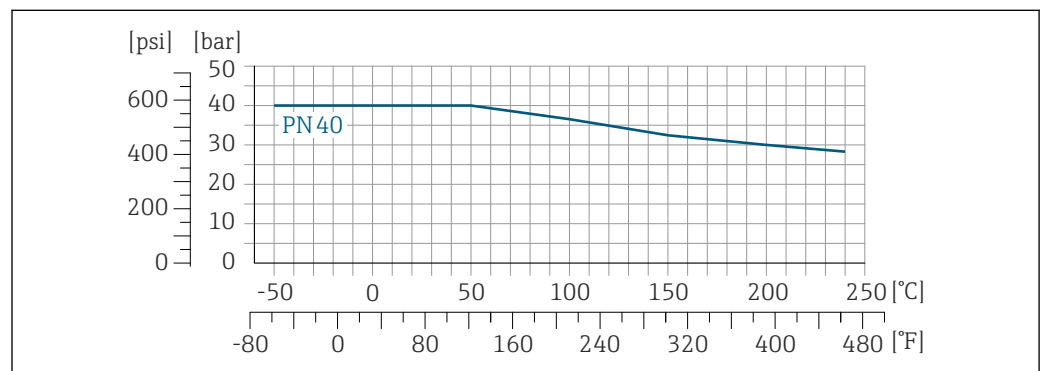

A0028784-EN

30 With flange material 1.4301 (F304); wetted parts Alloy C22

**Lap joint flange according to ASME B16.5**

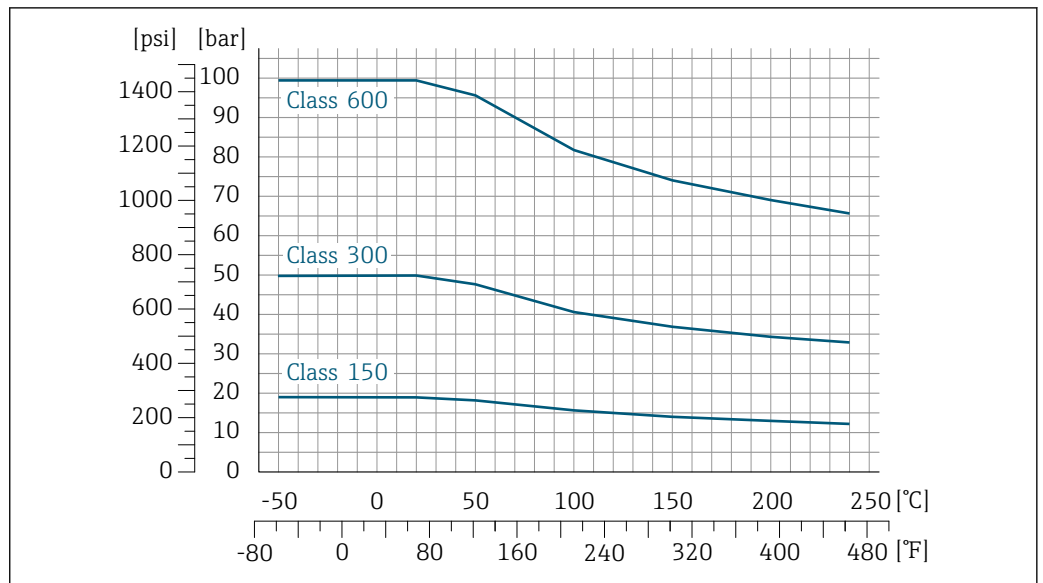

31 With flange material 1.4301 (F304); wetted parts Alloy C22

A0028785-EN

**Lap joint flange JIS B2220**

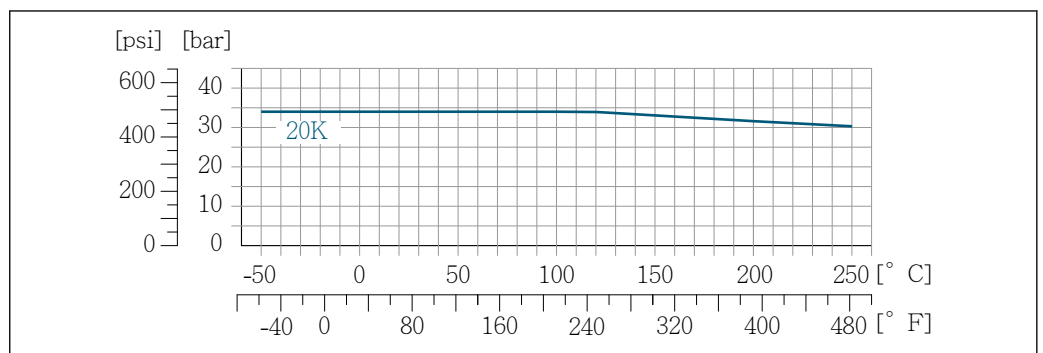

32 With flange material 1.4301 (F304); wetted parts Alloy C22

A0028786-EN

**Thread DIN 11851**

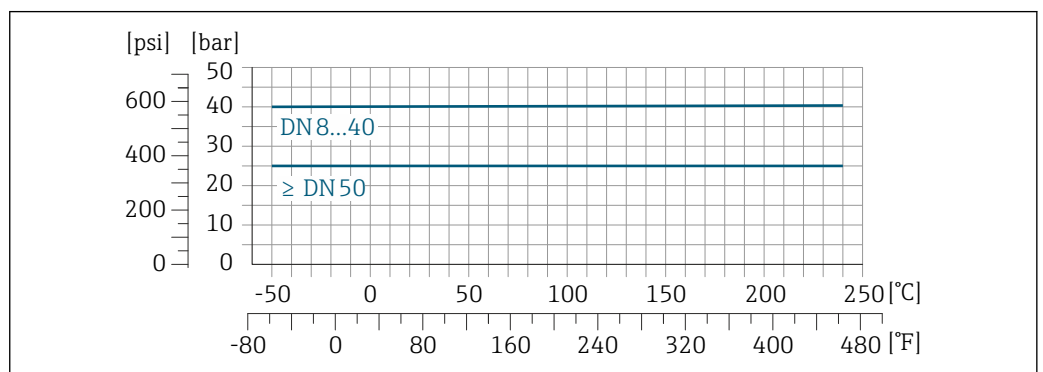

33 With connection material 1.4404 (316/316L)

A0028794-EN

DIN 11851 allows for applications up to +140 °C (+284 °F) if suitable sealing materials are used. Please take this into account when selecting seals and counterparts, as these components can limit the pressure and temperature range.

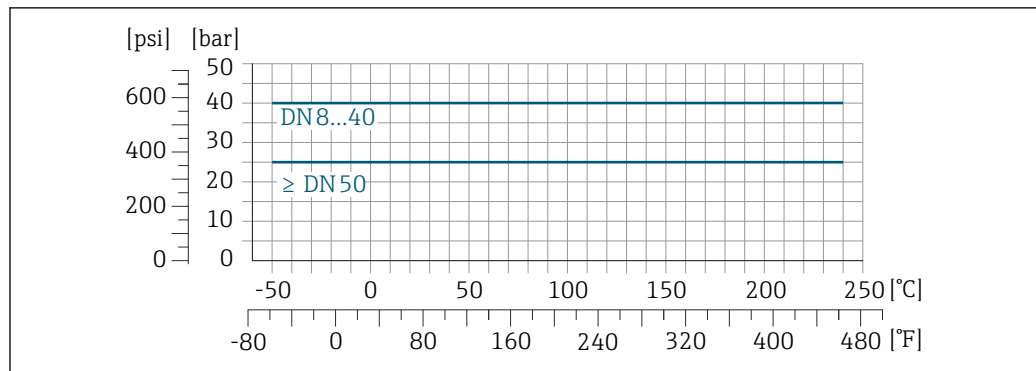
**Thread DIN 11864-1 Form A**

A0028798-EN

34 With connection material 1.4404 (316/316L)

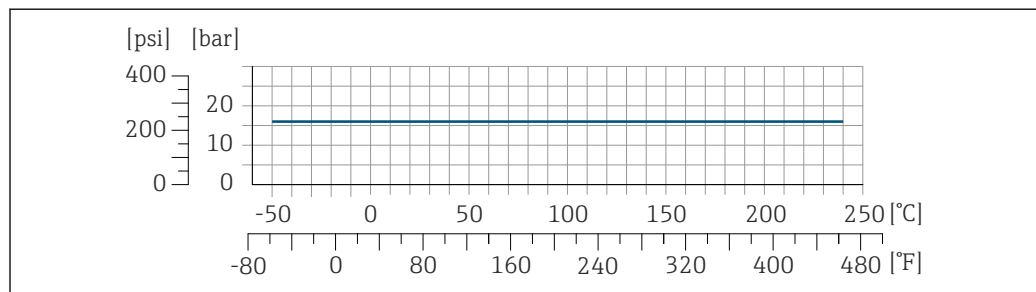
**Thread ISO 2853**

A0028799-EN

35 With connection material 1.4404 (316/316L)

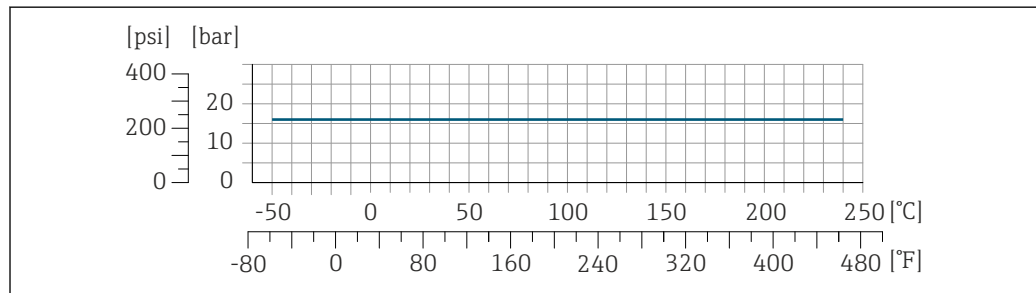
**Thread SMS 1145**

A0028800-EN

36 With connection material 1.4404 (316/316L)

SMS 1145 allows for applications up to 16 bar (232 psi) if suitable sealing materials are used. Please take this into account when selecting seals and counterparts, as these components can limit the pressure and temperature range.

VCO

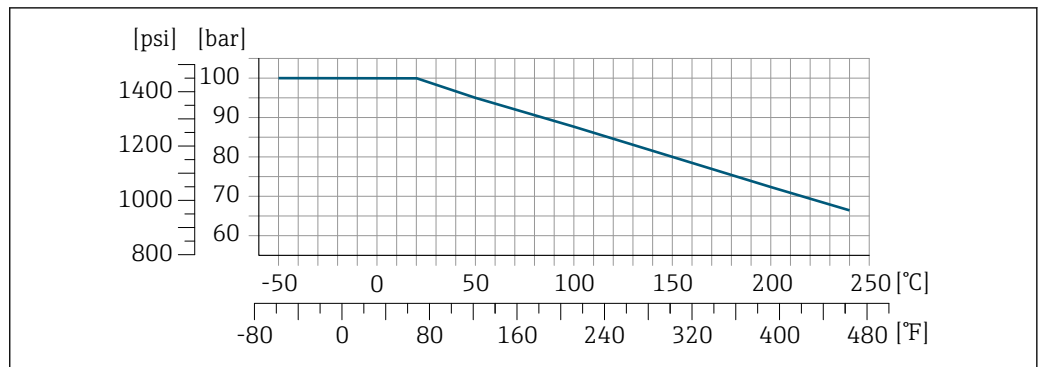

A0028801-EN

37 With connection material 1.4404 (316/316L)

Tri-Clamp

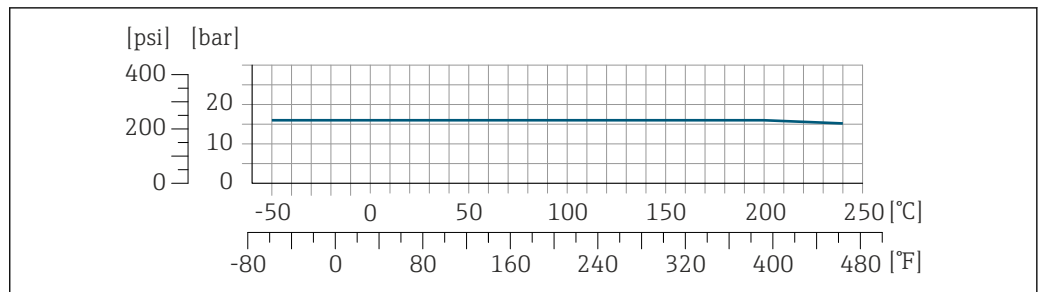

A0032216-EN

The clamp connections are suitable up to a maximum pressure of 16 bar (232 psi). Please observe the operating limits of the clamp and seal used as they can be over 16 bar (232 psi). The clamp and seal are not included in the scope of supply.

Sensor housing

For standard versions with the temperature range  $-50$  to  $+150$  °C ( $-58$  to  $+302$  °F), the sensor housing is filled with dry nitrogen gas and protects the electronics and mechanics inside.

For all other temperature versions the sensor housing is filled with dry inert gas.

**i** If a measuring tube fails (e.g. due to process characteristics like corrosive or abrasive fluids), the fluid will initially be contained by the sensor housing.

In the event of a tube failure, the pressure level inside the sensor housing will rise according to the operating process pressure. If the user judges that the sensor housing burst pressure does not provide an adequate safety margin, the device can be fitted with a rupture disk. This prevents excessively high pressure from forming inside the sensor housing. Therefore, the use of a rupture disk is strongly recommended in applications involving high gas pressures, and particularly in applications in which the process pressure is greater than  $2/3$  of the sensor housing burst pressure.

If there is a need to drain the leaking medium into a discharge device, the sensor should be fitted with a rupture disk. Connect the discharge to the additional threaded connection → 90.

If the sensor is to be purged with gas (gas detection), it should be equipped with purge connections.

**i** Do not open the purge connections unless the containment can be filled immediately with a dry, inert gas. Use only low pressure to purge.

Maximum pressure:

- DN 08 to 150 (3/8 to 6"): 5 bar (72.5 psi)
- DN 250 (10"):
  - Medium temperature  $\leq 100$  °C (212 °F): 5 bar (72.5 psi)
  - Medium temperature  $> 100$  °C (212 °F): 3 bar (43.5 psi)

### Burst pressure of the sensor housing

The following sensor housing burst pressures are only valid for standard devices and/or devices equipped with closed purge connections (not opened/as delivered).

If a device fitted with purge connections (order code for "Sensor option", option CH "Purge connection") is connected to the purge system, the maximum pressure is determined by the purge system itself or by the device, depending on which component has the lower pressure classification.

If the device is fitted with a rupture disk (order code for "Sensor option", option CA "Rupture disk"), the rupture disk trigger pressure is decisive.

The sensor housing burst pressure refers to a typical internal pressure which is reached prior to mechanical failure of the sensor housing and which was determined during type testing. The corresponding type test declaration can be ordered with the device (order code for "Additional approval", option LN "Sensor housing burst pressure, type test").

DN		Sensor housing burst pressure	
[mm]	[in]	[bar]	[psi]
8	$\frac{3}{8}$	400	5800
15	$\frac{1}{2}$	350	5070
25	1	280	4060
40	$1\frac{1}{2}$	260	3770
50	2	180	2610
80	3	120	1740
100	4	95	1370
150	6	75	1080
250	10	50	720

For information on the dimensions: see the "Mechanical construction" section

### Rupture disk



To increase the level of safety, a device version with a rupture disk with a trigger pressure of 10 to 15 bar (145 to 217.5 psi) can be used (order code for "Sensor option", option CA "rupture disk").

The use of rupture disks cannot be combined with the separately available heating jacket.

For information on the dimensions: see the "Mechanical construction" section (accessories) →  90

### Flow limit



Select the nominal diameter by optimizing between the required flow range and permissible pressure loss.

 For an overview of the full scale values for the measuring range, see the "Measuring range" section →  11

- The minimum recommended full scale value is approx. 1/20 of the maximum full scale value
- In most applications, 20 to 50 % of the maximum full scale value can be considered ideal
- A low full scale value must be selected for abrasive media (such as liquids with entrained solids): flow velocity < 1 m/s (< 3 ft/s).
- For gas measurement the following rules apply:
  - The flow velocity in the measuring tubes should not exceed half the sound velocity (0.5 Mach).
  - The maximum mass flow depends on the density of the gas: formula

 To calculate the flow limit, use the *Applicator* sizing tool →  130

### Pressure loss

 To calculate the pressure loss, use the *Applicator* sizing tool →  130

Promass F with reduced pressure loss: order code for "Sensor option", option CE "Reduced pressure loss"

### System pressure

It is important that cavitation does not occur, or that gases entrained in the liquids do not outgas. This is prevented by means of a sufficiently high system pressure.



For this reason, the following mounting locations are recommended:

- At the lowest point in a vertical pipe
- Downstream from pumps (no danger of vacuum)

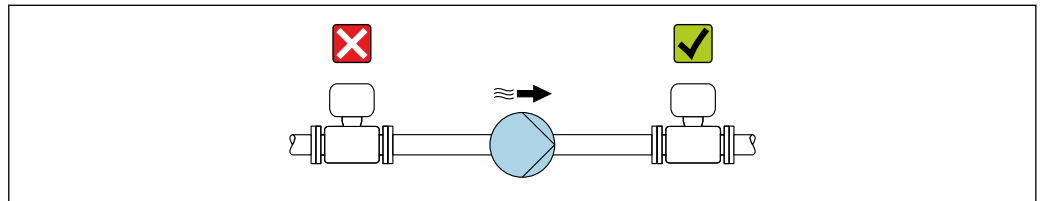

A0028777

### Thermal insulation

In the case of some fluids, it is important to keep the heat radiated from the sensor to the transmitter to a low level. A wide range of materials can be used for the required insulation.

The following device versions are recommended for versions with thermal insulation:

- Version with extended neck for insulation:  
Order code for "Sensor option", option CG with an extended neck length of 105 mm (4.13 in).
- Extended temperature version:  
Order code for "Measuring tube material", option SD, SE, SF or TH with an extended neck length of 105 mm (4.13 in).
- High-temperature version:  
Order code for "Measuring tube material", option TS, TT or TU with an extended neck length of 142 mm (5.59 in).

#### NOTICE

#### Electronics overheating on account of thermal insulation!

- ▶ Recommended orientation: horizontal orientation, transmitter housing pointing downwards.
- ▶ Do not insulate the transmitter housing .
- ▶ Maximum permissible temperature at the lower end of the transmitter housing: 80 °C (176 °F)
- ▶ Thermal insulation with not isolated extended neck: We recommend that you do not insulate the extended neck in order to ensure optimum dissipation of heat.

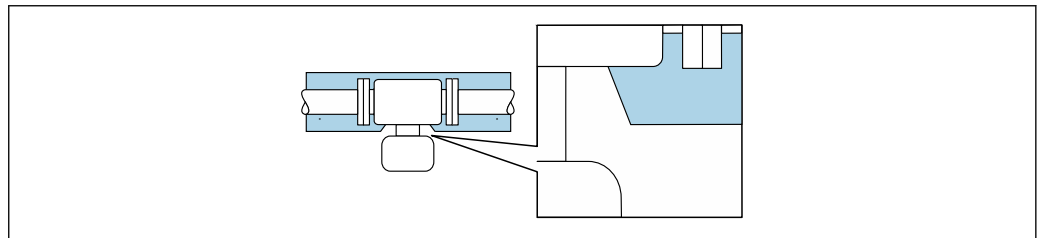

A0034391

38 Thermal insulation with not isolated extended neck

- i** Low-temperature version: It is generally not necessary to insulate the transmitter housing . If insulation is provided, the rules that apply are the same as those for thermal insulation.

### Heating

Some fluids require suitable measures to avoid loss of heat at the sensor.

#### Heating options

- Electrical heating, e.g. with electric band heaters <sup>1)</sup>
- Via pipes carrying hot water or steam
- Via heating jackets

- i** Heating jackets for the sensors can be ordered as accessories from Endress+Hauser → 129.

1) The use of parallel electric band heaters is generally recommended (bidirectional electricity flow). Particular considerations must be made if a single-wire heating cable is to be used. Additional information is provided in the document EA01339D "Installation instructions for electrical trace heating systems" → 133

**NOTICE****Danger of overheating when heating**

- ▶ Ensure that the temperature at the lower end of the transmitter housing does not exceed 80 °C (176 °F).
- ▶ Ensure that sufficient convection takes place at the transmitter neck.
- ▶ Ensure that a sufficiently large area of the transmitter neck remains exposed. The uncovered part serves as a radiator and protects the electronics from overheating and excessive cooling.
- ▶ When using in potentially explosive atmospheres, observe the information in the device-specific Ex documentation. For detailed information on the temperature tables, see the separate document entitled "Safety Instructions" (XA) for the device.

---

**Vibrations**

The high oscillation frequency of the measuring tubes ensures that the correct operation of the measuring system is not influenced by plant vibrations.

## Custody transfer

The measuring device is optionally tested in accordance with OIML R117/R81 and has an EU type evaluation certificate which authorizes the use in EU type-examination certificates according to Measuring Instruments Directive 2014/32/EU for service subject to legal metrological control ("custody transfer") for liquids other than water and cryogenic liquids (Annex VII).

The measuring device is optionally tested according to OIML R137 and has an EU type-examination certificate according to Measuring Instruments Directive 2014/32/EU for service subject to legal metrological control ("custody transfer") as a gas meter (Annex IV).

The device is used with a legally controlled totalizer on the local display and optionally with legally controlled outputs.

Measuring devices subject to legal metrological control totalize in both directions, i.e. all the outputs consider flow components in the positive (forward) and negative (reverse) flow direction.

Generally a measuring device subject to legal metrological control is secured against tampering by seals on the transmitter or sensor. These seals may normally only be opened by a representative of the competent authority for legal metrology controls.

After putting the device into circulation or after sealing the device, operation is only possible to a limited extent.

Detailed ordering information is available from your local Endress+Hauser sales center for national approvals, which are based on the OIML certificates, for applications with liquids other than water, cryogenic liquids or gases.



More information is provided in the supplementary documentation.

## Mechanical construction

Dimensions in SI units

Compact version

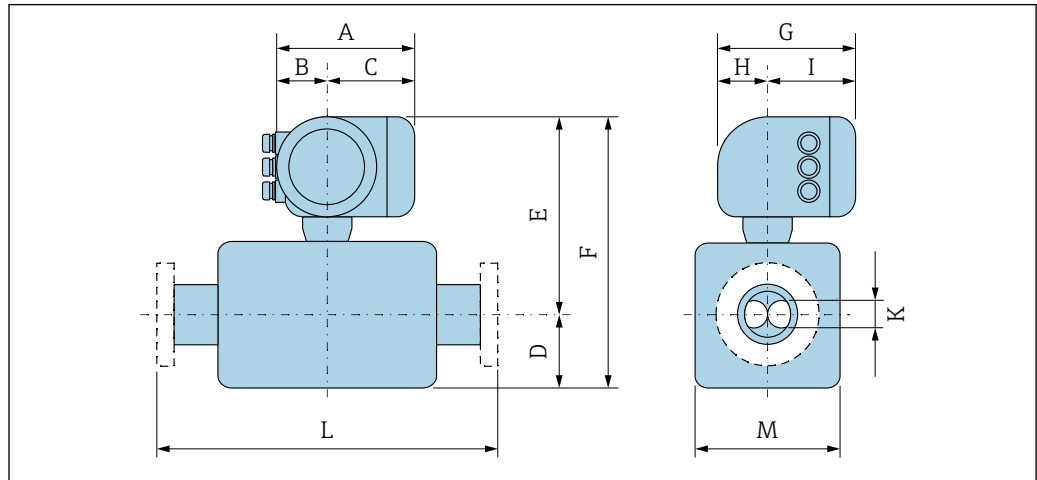

A0033786

Order code for "Housing", option A "Aluminum, coated"

DN [mm]	A <sup>1)</sup> [mm]	B <sup>1)</sup> [mm]	C [mm]	D [mm]	E <sup>2) 3)</sup> [mm]	F <sup>2) 3)</sup> [mm]	G <sup>4)</sup> [mm]	H [mm]	I <sup>4)</sup> [mm]	K [mm]	L [mm]	M [mm]
8	169	68	101	75	259.5	334.5	200	59	141	5.35	<sup>5)</sup>	70
15	169	68	101	75	259.5	334.5	200	59	141	8.31	<sup>5)</sup>	70
25	169	68	101	75 <sup>6)</sup>	259.5	334.5	200	59	141	12.0	<sup>5)</sup>	70
40	169	68	101	105	264.5	369.5	200	59	141	17.6	<sup>5)</sup>	79
50	169	68	101	141	274.5	415.5	200	59	141	26.0	<sup>5)</sup>	99
80	169	68	101	200	294.5	494.5	200	59	141	40.5	<sup>5)</sup>	139
100	169	68	101	254	312.5	566.5	200	59	141	51.2	<sup>5)</sup>	176
150	169	68	101	378	333.5	711.5	200	59	141	68.9	<sup>5)</sup>	218
250	169	68	101	548	377.5	925.5	200	59	141	102.3	<sup>5)</sup>	305

- 1) Depending on the cable gland used: values up to + 30 mm
- 2) With order code for "Sensor option", option CG or order code for "Measuring tube material", option SD, SE, SF, TH, LA: values +70 mm
- 3) With order code for "Measuring tube material", option TS, TT, TU: values +102 mm
- 4) For version without local display: values - 30 mm
- 5) Depending on the process connection
- 6) With order code for "Measuring tube material", option TT, TU: value +25 mm

Order code for "Housing", option A "Aluminum, coated"; Ex d

DN [mm]	A <sup>1)</sup> [mm]	B <sup>1)</sup> [mm]	C [mm]	D [mm]	E <sup>2) 3)</sup> [mm]	F [mm]	G <sup>4)</sup> [mm]	H [mm]	I <sup>4)</sup> [mm]	K [mm]	L [mm]	M [mm]
8	188	85	103	75	260.5	335.5	217	58	159	5.35	<sup>5)</sup>	70
15	188	85	103	75	260.5	335.5	217	58	159	8.31	<sup>5)</sup>	70
25	188	85	103	75 <sup>6)</sup>	260.5	335.5	217	58	159	12.0	<sup>5)</sup>	70
40	188	85	103	105	265	370	217	58	159	17.6	<sup>5)</sup>	79
50	188	85	103	141	275	416	217	58	159	26.0	<sup>5)</sup>	99
80	188	85	103	200	295	495	217	58	159	40.5	<sup>5)</sup>	139
100	188	85	103	254	313.5	567.5	217	58	159	51.2	<sup>5)</sup>	176

DN	A <sup>1)</sup>	B <sup>1)</sup>	C	D	E <sup>2) 3)</sup>	F	G <sup>4)</sup>	H	I <sup>4)</sup>	K	L	M
[mm]	[mm]	[mm]	[mm]	[mm]	[mm]	[mm]	[mm]	[mm]	[mm]	[mm]	[mm]	[mm]
150	188	85	103	378	334.5	712.5	217	58	159	68.9	<sup>5)</sup>	218
250	188	85	103	548	378	926	217	58	159	102.3	<sup>5)</sup>	305

- 1) Depending on the cable gland used: values up to + 30 mm
- 2) With order code for "Sensor option", option CG or order code for "Measuring tube material", option SD, SE, SF, TH, LA: values +70 mm
- 3) With order code for "Measuring tube material", option TS, TT, TU: values +102 mm
- 4) For version without local display: values - 40 mm
- 5) Depending on the process connection
- 6) With order code for "Measuring tube material", option TT, TU: value +25 mm

*Order code for "Housing", option B "Stainless, hygienic"*

DN	A <sup>1)</sup>	B <sup>1)</sup>	C	D	E <sup>2) 3)</sup>	F	G <sup>4)</sup>	H	I <sup>4)</sup>	K	L	M
[mm]	[mm]	[mm]	[mm]	[mm]	[mm]	[mm]	[mm]	[mm]	[mm]	[mm]	[mm]	[mm]
8	183	73	110	75	259.5	334.5	200	65	135	5.35	<sup>5)</sup>	70
15	183	73	110	75	259.5	334.5	200	65	135	8.31	<sup>5)</sup>	70
25	183	73	110	75 <sup>6)</sup>	259.5	334.5	200	65	135	12.0	<sup>5)</sup>	70
40	183	73	110	105	264.5	369.5	200	65	135	17.6	<sup>5)</sup>	79
50	183	73	110	141	274.5	415.5	200	65	135	26.0	<sup>5)</sup>	99
80	183	73	110	200	294.5	494.5	200	65	135	40.5	<sup>5)</sup>	139
100	183	73	110	254	312.5	566.5	200	65	135	51.2	<sup>5)</sup>	176
150	183	73	110	378	333.5	711.5	200	65	135	68.9	<sup>5)</sup>	218
250	183	73	110	548	377.5	925.5	200	65	135	102.3	<sup>5)</sup>	305

- 1) Depending on the cable gland used: values up to + 30 mm
- 2) With order code for "Sensor option", option CG or order code for "Measuring tube material", option SD, SE, SF, TH, LA: values +70 mm
- 3) With order code for "Measuring tube material", option TS, TT, TU: values +102 mm
- 4) For version without local display: values - 13 mm
- 5) Depending on the process connection
- 6) With order code for "Measuring tube material", option TT, TU: value +25 mm

*Order code for "Housing", option L "Cast, stainless"*

DN	A <sup>1)</sup>	B <sup>1)</sup>	C	D	E <sup>2) 3)</sup>	F	G	H	I	K	L	M
[mm]	[mm]	[mm]	[mm]	[mm]	[mm]	[mm]	[mm]	[mm]	[mm]	[mm]	[mm]	[mm]
8	186	85	101	75	260	335	217	60	157	5.35	<sup>4)</sup>	70
15	186	85	101	75	260	335	217	60	157	8.31	<sup>4)</sup>	70
25	186	85	101	75 <sup>5)</sup>	260	335	217	60	157	12.0	<sup>4)</sup>	70
40	186	85	101	105	264.5	369.5	217	60	157	17.6	<sup>4)</sup>	79
50	186	85	101	141	274.5	415.5	217	60	157	26.0	<sup>4)</sup>	99
80	186	85	101	200	294.5	494.5	217	60	157	40.5	<sup>4)</sup>	139
100	186	85	101	254	313	567	217	60	157	51.2	<sup>4)</sup>	176

DN	A <sup>1)</sup>	B <sup>1)</sup>	C	D	E <sup>2) 3)</sup>	F	G	H	I	K	L	M
[mm]	[mm]	[mm]	[mm]	[mm]	[mm]	[mm]	[mm]	[mm]	[mm]	[mm]	[mm]	[mm]
150	186	85	101	378	334	712	217	60	157	68.9	<sup>4)</sup>	218
250	186	85	101	548	377.5	925.5	217	60	157	102.3	<sup>4)</sup>	305

- 1) Depending on the cable gland used: values up to + 30 mm
- 2) With order code for "Sensor option", option CG or order code for "Measuring tube material", option SD, SE, SF, TH, LA: values +70 mm
- 3) With order code for "Measuring tube material", option TS, TT, TU: values +102 mm
- 4) Depending on the process connection
- 5) With order code for "Measuring tube material", option TT, TU: value +25 mm

**Flange connections**

Fixed flange EN 1092-1, ASME B16.5, JIS B2220

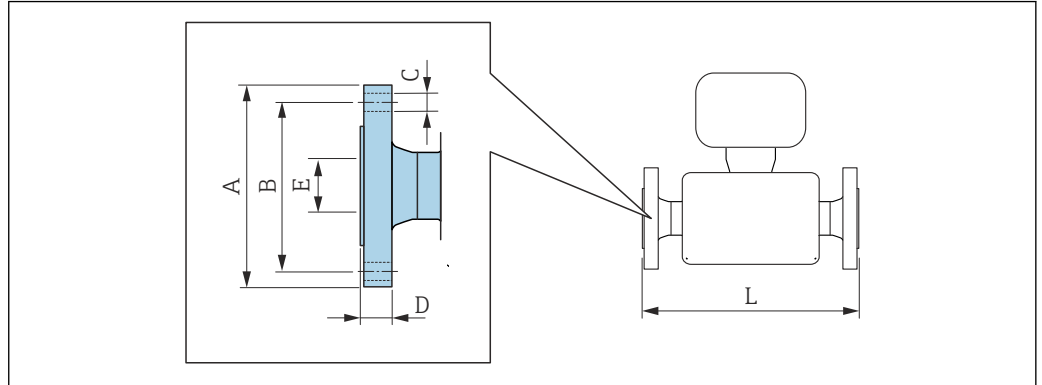

A0015621

- i** Length tolerance for dimension L in mm:
  - DN ≤ 100: +1.5 / -2.0
  - DN ≥ 150: ±3.5

<b>Flange according to EN 1092-1 (DIN 2501): PN16</b> 1.4404 (F316/F316L): order code for "Process connection", option D1S Alloy C22: order code for "Process connection", option D1C						
<b>Flange with groove according to EN 1092-1 Form D (DIN 2512N): PN16</b> 1.4404 (F316/F316L): order code for "Process connection", option D5S Alloy C22: order code for "Process connection", option D5C						
DN [mm]	A [mm]	B [mm]	C [mm]	D [mm]	E [mm]	L [mm]
100	220	180	8 × Ø18	20	107.1	1 127/1 400 <sup>1)</sup>
150	285	240	8 × Ø22	22	159.3	1 330/1 700 <sup>1)</sup>
250	405	355	12 × Ø26	26	260.4	1 775
Surface roughness (flange): EN 1092-1 Form B1 (DIN 2526 Form C), Ra 3.2 to 12.5 µm						

1) Installed length in accordance with NAMUR recommendation NE 132 optionally available (order code for "Process connection", option D1N or D5N (with groove))

<b>Flange according to EN 1092-1 (DIN 2501): PN16 with reduction in nominal diameter</b> 1.4404 (F316/F316L)								
DN [mm]	Reduction to DN [mm]	Order code for "Process connection", option	A [mm]	B [mm]	C [mm]	D [mm]	E [mm]	L [mm]
100	80	DHS	220	180	8 × Ø18	20	107.1	874
150	100	DJS	285	240	8 × Ø22	22	159.3	1 167
200	150	DLS	340	295	12 × Ø22	24	206.5	1 461
Surface roughness (flange): EN 1092-1 Form B1 (DIN 2526 Form C), Ra 3.2 to 12.5 µm								

<b>Flange according to EN 1092-1 (DIN 2501): PN 40</b> 1.4404 (F316/F316L): order code for "Process connection", option D2S Alloy C22: order code for "Process connection", option D2C						
<b>Flange with groove according to EN 1092-1 Form D (DIN 2512N): PN 40</b> 1.4404 (F316/F316L): order code for "Process connection", option D6S Alloy C22: order code for "Process connection", option D6C						
DN [mm]	A [mm]	B [mm]	C [mm]	D [mm]	E [mm]	L [mm]
8 <sup>1)</sup>	95	65	4 × Ø14	16	17.3	370/510 <sup>2)</sup>
15	95	65	4 × Ø14	16	17.3	404/510 <sup>2)</sup>
25	115	85	4 × Ø14	18	28.5	440/600 <sup>2)</sup>
40	150	110	4 × Ø18	18	43.1	550
50	165	125	4 × Ø18	20	54.5	715/715 <sup>2)</sup>
80	200	160	8 × Ø18	24	82.5	840/915 <sup>2)</sup>
100	235	190	8 × Ø22	24	107.1	1 127
150	300	250	8 × Ø26	28	159.3	1 370
250	450	385	12 × Ø33	38	258.8	1 845

Surface roughness (flange): EN 1092-1 Form B1 (DIN 2526 Form C), Ra 3.2 to 12.5 µm

- 1) DN 8 with DN 15 flanges as standard
- 2) Installed length in accordance with NAMUR recommendation NE 132 optionally available (order code for "Process connection", option D2N or D6N (with groove))

<b>Flange according to EN 1092-1 (DIN 2501): PN 40 (with DN 25 flanges)</b> 1.4404 (F316/F316L): order code for "Process connection", option R2S						
DN [mm]	A [mm]	B [mm]	C [mm]	D [mm]	E [mm]	L [mm]
8	115	85	4 × Ø14	18	28.5	440
15	115	85	4 × Ø14	18	28.5	440

Surface roughness (flange): EN 1092-1 Form B1 (DIN 2526 Form C), Ra 3.2 to 12.5 µm

<b>Flange according to EN 1092-1 (DIN 2501): PN 40 with reduction in nominal diameter</b> 1.4404 (F316/F316L)								
DN [mm]	Reduction to DN [mm]	Order code for "Process connection", option	A [mm]	B [mm]	C [mm]	D [mm]	E [mm]	L [mm]
50	40	DFS	165	125	4 × Ø18	20	54.5	555
80	50	DGS	200	160	8 × Ø18	24	82.5	840
100	80	DIS	235	190	8 × Ø22	24	107.1	874
150	100	DKS	300	250	8 × Ø26	28	159.3	1 167
200	150	DMS	375	320	12 × Ø30	34	206.5	1 461

Surface roughness (flange): EN 1092-1 Form B1 (DIN 2526 Form C), Ra 3.2 to 12.5 µm



**Flange according to EN 1092-1 (DIN 2501): PN 63**  
**1.4404 (F316/F316L):** order code for "Process connection", option D3S  
**Alloy C22:** order code for "Process connection", option D3C

**Flange with groove according to EN 1092-1 Form D (DIN 2512N): PN 63**  
**1.4404 (F316/F316L):** order code for "Process connection", option D7S  
**Alloy C22:** order code for "Process connection", option D7C

DN [mm]	A [mm]	B [mm]	C [mm]	D [mm]	E [mm]	L [mm]
50	180	135	4 × Ø22	26	54.5	724
80	215	170	8 × Ø22	28	81.7	875
100	250	200	8 × Ø26	30	106.3	1127
150	345	280	8 × Ø33	36	157.1	1410
250	470	400	12 × Ø36	46	255.4	1885

Surface roughness (flange):  
 EN 1092-1 Form B1 (DIN 2526 Form C), Ra 3.2 to 12.5 µm EN 1092-1 Form B2 (DIN 2526 Form E), Ra 0.8 to 3.2 µm

**Flange according to EN 1092-1 (DIN 2501): PN 100**  
**1.4404 (F316/F316L):** order code for "Process connection", option D4S  
**Alloy C22:** order code for "Process connection", option D4C

**Flange with groove according to EN 1092-1 Form D (DIN 2512N): PN 100**  
**1.4404 (F316/F316L):** order code for "Process connection", option D8S  
**Alloy C22:** order code for "Process connection", option D8C

DN [mm]	A [mm]	B [mm]	C [mm]	D [mm]	E [mm]	L [mm]
8 <sup>1)</sup>	105	75	4 × Ø14	20	17.3	400
15	105	75	4 × Ø14	20	17.3	420
25	140	100	4 × Ø18	24	28.5	470
40	170	125	4 × Ø22	26	42.5	590
50	195	145	4 × Ø26	28	53.9	740
80	230	180	8 × Ø26	32	80.9	885
100	265	210	8 × Ø30	36	104.3	1127
150	355	290	12 × Ø33	44	154.0	1450

Surface roughness (flange): EN 1092-1 Form B2 (DIN 2526 Form E), Ra 0.8 to 3.2 µm

1) DN 8 with DN 15 flanges as standard

**Flange according to EN 1092-1 (DIN 2501): PN 100**  
**Alloy C22:** order code for "Process connection", option D4C

**Flange with groove according to EN 1092-1 Form D (DIN 2512N): PN 100**  
**Alloy C22:** order code for "Process connection", option D8C

DN [mm]	A [mm]	B [mm]	C [mm]	D [mm]	E [mm]	L [mm]
250	505	430	12 × Ø39	60	248.0	1949

Surface roughness (flange): EN 1092-1 Form B2 (DIN 2526 Form E), Ra 0.8 to 3.2 µm

<b>Flange according to ASME B16.5: Class 150</b> 1.4404 (F316/F316L): order code for "Process connection", option AAS Alloy C22: order code for "Process connection", option AAC						
DN [mm]	A [mm]	B [mm]	C [mm]	D [mm]	E [mm]	L [mm]
8 <sup>1)</sup>	90	60.3	4 × Ø15.7	11.2	15.7	370
15	90	60.3	4 × Ø15.7	11.2	15.7	404
25	110	79.4	4 × Ø15.7	14.2	26.7	440
40	125	98.4	4 × Ø15.9	15.9	40.9	550
50	150	120.7	4 × Ø19.1	19.1	52.6	715
80	190	152.4	4 × Ø19.1	23.9	78.0	840
100	230	190.5	8 × Ø19.1	23.9	102.4	1127
150	280	241.3	8 × Ø22.4	25.4	154.2	1398
250	405	362	12 × Ø25.4	30.2	254.5	1832
Surface roughness (flange): Ra 3.2 to 6.3 µm						

1) DN 8 with DN 15 flanges as standard

<b>Flange according to ASME B16.5: Class 150 with reduction in nominal diameter</b> 1.4404 (F316/F316L)								
DN [mm]	Reduction to DN [mm]	Order code for "Process connection", option	A [mm]	B [mm]	C [mm]	D [mm]	E [mm]	L [mm]
50	40	AHS	150	120.7	4 × Ø19.1	19.1	52.6	550
80	50	AJS	190	152.4	4 × Ø19.1	23.9	78.0	720
100	80	ALS	230	190.5	8 × Ø19.1	23.9	102.4	874
150	100	ANS	280	241.3	8 × Ø22.4	25.4	154.2	1167
200	150	APS	345	298.5	8 × Ø22.4	29	202.7	1461
Surface roughness (flange): Ra 3.2 to 6.3 µm								

<b>Flange according to ASME B16.5: Class 300</b> 1.4404 (F316/F316L): order code for "Process connection", option ABS Alloy C22: order code for "Process connection", option ABC						
DN [mm]	A [mm]	B [mm]	C [mm]	D [mm]	E [mm]	L [mm]
8 <sup>1)</sup>	95	66.7	4 × Ø15.7	14.2	15.7	370
15	95	66.7	4 × Ø15.7	14.2	15.7	404
25	125	88.9	4 × Ø19.1	17.5	26.7	440
40	155	114.3	4 × Ø22.3	20.6	40.9	550
50	165	127	8 × Ø19.1	22.3	52.6	715
80	210	168.3	8 × Ø22.3	28.4	78.0	840
100	255	200	8 × Ø22.3	31.7	102.4	1127
150	320	269.9	12 × Ø22.3	36.5	154.2	1417
250	445	387.4	16 × Ø28.4	47.4	254.5	1863
Surface roughness (flange): Ra 3.2 to 6.3 µm						

1) DN 8 with DN 15 flanges as standard

Flange according to ASME B16.5: Class 300 with reduction in nominal diameter 1.4404 (F316/F316L)								
DN [mm]	Reduction to DN [mm]	Order code for "Process connection", option	A [mm]	B [mm]	C [mm]	D [mm]	E [mm]	L [mm]
50	40	AIS	165	127	8 × Ø19.1	22.3	52.6	615
80	50	AKS	210	168.3	8 × Ø22.3	28.4	78.0	732
100	80	AMS	255	200	8 × Ø22.3	31.7	102.4	894
150	100	AOS	320	269.9	12 × Ø22.3	36.5	154.2	1187
200	150	AQS	380	330.2	12 × Ø25.4	41.7	202.7	1461
Surface roughness (flange): Ra 3.2 to 6.3 µm								

Flange according to ASME B16.5: Class 600 1.4404 (F316/F316L): order code for "Process connection", option ACS Alloy C22: order code for "Process connection", option ACC						
DN [mm]	A [mm]	B [mm]	C [mm]	D [mm]	E [mm]	L [mm]
8 <sup>1)</sup>	95	66.7	4 × Ø15.7	20.6	13.9	400
15	95	66.7	4 × Ø15.7	20.6	13.9	420
25	125	88.9	4 × Ø19.1	23.9	24.3	490
40	155	114.3	4 × Ø22.3	28.7	38.1	600
50	165	127	8 × Ø19.1	31.8	49.2	742
80	210	168.3	8 × Ø22.3	38.2	73.7	900
100	275	215.9	8 × Ø25.4	48.4	97.3	1157
150	355	292.1	12 × Ø28.4	47.8	154.2	1467
250	510	431.8	16 × Ø35.1	69.9	254.5	1946
Surface roughness (flange): Ra 3.2 to 6.3 µm						

1) DN 8 with DN 15 flanges as standard

Flange JIS B2220: 10K 1.4404 (F316/F316L): order code for "Process connection", option NDS Alloy C22: order code for "Process connection", option NDC						
DN [mm]	A [mm]	B [mm]	C [mm]	D [mm]	E [mm]	L [mm]
50	155	120	4 × Ø19	16	50	715
80	185	150	8 × Ø19	18	80	832
100	210	175	8 × Ø19	18	100	1127
150	280	240	8 × Ø23	22	150	1354
250	400	355	12 × Ø25	24	250	1775
Surface roughness (flange): Ra 3.2 to 6.3 µm						

<b>Flange JIS B2220: 20K</b>						
1.4404 (F316/F316L): order code for "Process connection", option NES						
Alloy C22: order code for "Process connection", option NEC						
DN [mm]	A [mm]	B [mm]	C [mm]	D [mm]	E [mm]	L [mm]
8 <sup>1)</sup>	95	70	4 × Ø15	14	15	370
15	95	70	4 × Ø15	14	15	404
25	125	90	4 × Ø19	16	25	440
40	140	105	4 × Ø19	18	40	550
50	155	120	8 × Ø19	18	50	715
80	200	160	8 × Ø23	22	80	832
100	225	185	8 × Ø23	24	100	1127
150	305	260	12 × Ø25	28	150	1386
250	430	380	12 × Ø27	34	250	1845
Surface roughness (flange): Ra 1.6 to 3.2 µm						

1) DN 8 with DN 15 flanges as standard

<b>Flange JIS B2220: 40K</b>						
1.4404 (F316/F316L): order code for "Process connection", option NGS						
Alloy C22: order code for "Process connection", option NGC						
DN [mm]	A [mm]	B [mm]	C [mm]	D [mm]	E [mm]	L [mm]
8 <sup>1)</sup>	115	80	4 × Ø19	20	15	400
15	115	80	4 × Ø19	20	15	425
25	130	95	4 × Ø19	22	25	485
40	160	120	4 × Ø23	24	38	600
50	165	130	8 × Ø19	26	50	760
80	210	170	8 × Ø23	32	75	890
100	250	205	8 × Ø25	36	100	1167
150	355	295	12 × Ø33	44	150	1498
Surface roughness (flange): Ra 1.6 to 3.2 µm						

1) DN 8 with DN 15 flanges as standard

<b>Flange JIS B2220: 63K</b>						
1.4404 (F316/F316L): order code for "Process connection", option NHS						
Alloy C22: order code for "Process connection", option NHC						
DN [mm]	A [mm]	B [mm]	C [mm]	D [mm]	E [mm]	L [mm]
8 <sup>1)</sup>	120	85	4 × Ø19	23	12	420
15	120	85	4 × Ø19	23	12	440
25	140	100	4 × Ø23	27	22	494
40	175	130	4 × Ø25	32	35	620
50	185	145	8 × Ø23	34	48	775
80	230	185	8 × Ø25	40	73	915
100	270	220	8 × Ø27	44	98	1167

<b>Flange JIS B2220: 63K</b> <b>1.4404 (F316/F316L): order code for "Process connection", option NHS</b> <b>Alloy C22: order code for "Process connection", option NHC</b>						
DN [mm]	A [mm]	B [mm]	C [mm]	D [mm]	E [mm]	L [mm]
150	365	305	12 × Ø33	54	146	1528
Surface roughness (flange): Ra 1.6 to 3.2 µm						

- 1) DN 8 with DN 15 flanges as standard

## Fixed flange DIN 11864-2

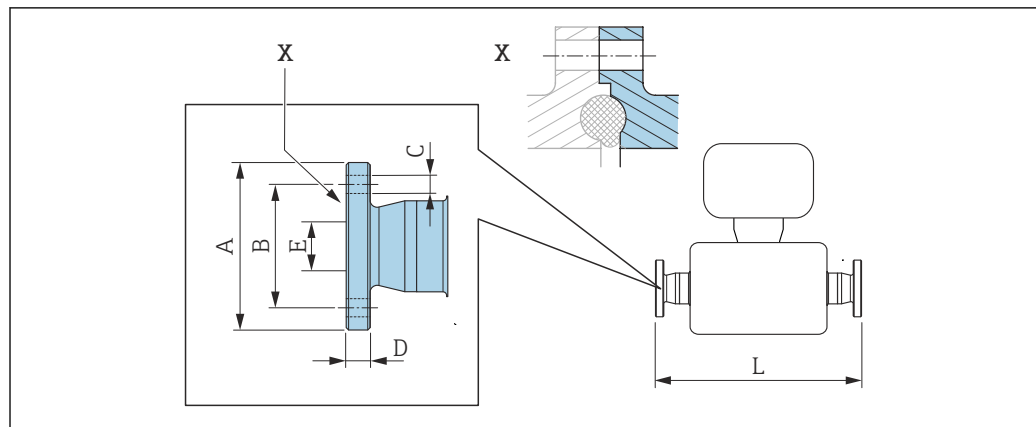

A0015627

39 Detail X: Asymmetrical process connection; the part shown in blue is provided by the supplier.

**i** Length tolerance for dimension L in mm:  
+1.5 / -2.0

**Flange DIN11864-2 Form A, for pipe according to DIN11866 series A, flange with notch 1.4404 (316/316L)**

Order code for "Process connection", option KCS

DN [mm]	A [mm]	B [mm]	C [mm]	D [mm]	E [mm]	L [mm]
8 <sup>1)</sup>	54	37	4 × Ø9	10	10	387
15	59	42	4 × Ø9	10	16	418
25	70	53	4 × Ø9	10	26	454
40	82	65	4 × Ø9	10	38	560
50	94	77	4 × Ø9	10	50	720
80	133	112	8 × Ø11	12	81	900
100	159	137	8 × Ø11	14	100	1127

3A version available: order code for "Additional approval", option LP in conjunction with  
 $Ra_{max} = 0.76 \mu\text{m}$ : order code for "Measuring tube material", option SB, SE or  
 $Ra_{max} = 0.38 \mu\text{m}$ : order code for "Measuring tube material", option SC, SF  
 $Ra_{max} = 0.38 \mu\text{m}$  electropolished: order code for "Measuring tube material", option BC

1) DN 8 with DN 10 flanges as standard

Lap joint flange EN 1092-1, ASME B16.5, JIS B2220

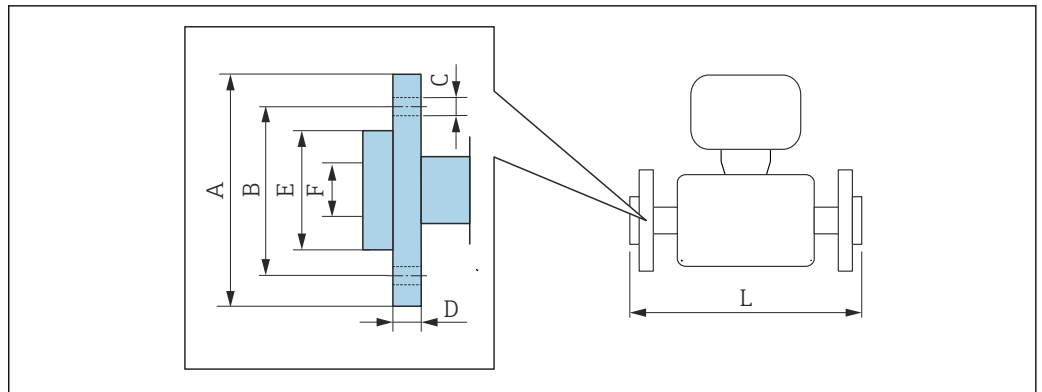

A0022221

 Length tolerance for dimension L in mm:  
+1.5 / -2.0

Lap joint flange according to EN 1092-1 Form D: PN 40 1.4301 (F304), wetted parts Alloy C22 Order code for "Process connection", option DAC								
DN [mm]	A [mm]	B [mm]	C [mm]	D [mm]	E [mm]	F [mm]	L [mm]	L <sub>diff</sub> <sup>1)</sup> [mm]
8 <sup>2)</sup>	95	65	4 × Ø14	14.5	45	17.3	370	0
15	95	65	4 × Ø14	14.5	45	17.3	404	0
25	115	85	4 × Ø14	16.5	68	28.5	444	+4
40	150	110	4 × Ø18	21	88	43.1	560	+10
50	165	125	4 × Ø18	23	102	54.5	719	+4
80	200	160	8 × Ø18	29	138	82.5	848	+8
100	235	190	8 × Ø22	34	162	107.1	1 131	+4

Surface roughness (flange): Ra 3.2 to 12.5 µm

- 1) Difference to installed length of the welding neck flange (order code for "Process connection", option D2C)
- 2) DN 8 with DN 15 flanges as standard

Lap joint flange according to ASME B16.5: Class 150 1.4301 (F304), wetted parts Alloy C22 Order code for "Process connection", option ADC								
DN [mm]	A [mm]	B [mm]	C [mm]	D [mm]	E [mm]	F [mm]	L [mm]	L <sub>diff</sub> <sup>1)</sup> [mm]
8 <sup>2)</sup>	90	60.3	4 × Ø 15.7	15	35.1	15.7	370	0
15	90	60.3	4 × Ø 15.7	15	35.1	15.7	404	0
25	110	79.4	4 × Ø 15.7	16	50.8	26.7	440	0
40	125	98.4	4 × Ø 15.7	15.9	73.2	40.9	550	0
50	150	120.7	4 × Ø 19.1	19	91.9	52.6	715	0
80	190	152.4	4 × Ø 19.1	22.3	127.0	78.0	840	0
100	230	190.5	8 × Ø 19.1	26	157.2	102.4	1 127	0

Surface roughness (flange): Ra 3.2 to 12.5 µm

- 1) Difference to installed length of the welding neck flange (order code for "Process connection", option AAC)
- 2) DN 8 with DN 15 flanges as standard

<b>Lap joint flange according to ASME B16.5: Class 300</b>								
1.4301 (F304), wetted parts Alloy C22								
Order code for "Process connection", option AEC								
DN [mm]	A [mm]	B [mm]	C [mm]	D [mm]	E [mm]	F [mm]	L [mm]	L <sub>diff</sub> <sup>1)</sup> [mm]
8 <sup>2)</sup>	95	66.7	4 × Ø 15.7	16.5	35.1	15.7	376	+6
15	95	66.7	4 × Ø 15.7	16.5	35.1	15.7	406	+2
25	125	88.9	4 × Ø 19.1	21.0	50.8	26.7	450	+10
40	155	114.3	4 × Ø 22.3	23.0	73.2	40.9	564	+14
50	165	127	8 × Ø 19.1	25.5	91.9	52.6	717	+2
80	210	168.3	8 × Ø 22.3	31.0	127.0	78.0	852.6	+12.6
100	255	200	8 × Ø 22.3	32.0	157.2	102.4	1 139	+12
Surface roughness (flange): Ra 3.2 to 12.5 µm								

- 1) Difference to installed length of the welding neck flange (order code for "Process connection", option ABC)  
 2) DN 8 with DN 15 flanges as standard

<b>Lap joint flange according to ASME B16.5: Class 600</b>								
1.4301 (F304), wetted parts Alloy C22								
Order code for "Process connection", option AFC								
DN [mm]	A [mm]	B [mm]	C [mm]	D [mm]	E [mm]	F [mm]	L [mm]	L <sub>diff</sub> <sup>1)</sup> [mm]
8 <sup>2)</sup>	95	66.7	4 × Ø 15.7	17.0	35.1	13.9	400	0
15	95	66.7	4 × Ø 15.7	17.0	35.1	13.9	420	0
25	125	88.9	4 × Ø 19.1	21.5	50.8	24.3	490	0
40	155	114.3	4 × Ø 22.3	25.0	73.2	38.1	600	0
50	165	127	8 × Ø 19.1	28.0	91.9	49.2	742	0
80	210	168.3	8 × Ø 22.3	35.0	127.0	73.7	900	0
100	275	215.9	8 × Ø 25.4	44.0	157.2	97.3	1 167	+10
Surface roughness (flange): Ra 3.2 to 12.5 µm								

- 1) Difference to installed length of the welding neck flange (order code for "Process connection", option ACC)  
 2) DN 8 with DN 15 flanges as standard

<b>Lap joint flange JIS B2220: 20K</b>								
1.4301 (F304), wetted parts Alloy C22								
Order code for "Process connection", option NIC								
DN [mm]	A [mm]	B [mm]	C [mm]	D [mm]	E [mm]	F [mm]	L [mm]	L <sub>diff</sub> <sup>1)</sup> [mm]
8 <sup>2)</sup>	95	70	4 × Ø 15	14	51	15	370	0
15	95	70	4 × Ø 15	14	51	15	404	0
25	125	90	4 × Ø 19	18.5	67	25	440	0
40	140	105	4 × Ø 19	18.5	81	40	550	0
50	155	120	8 × Ø 19	23	96	50	715	0
80	200	160	8 × Ø 23	29	132	80	844	+12
100	225	185	8 × Ø 23	29	160	100	1 127	0
Surface roughness (flange): Ra 3.2 to 12.5 µm								

- 1) Difference to installed length of the welding neck flange (order code for "Process connection", option NEC)  
 2) DN 8 with DN 15 flanges as standard



**Clamp connections**

*Tri-Clamp*

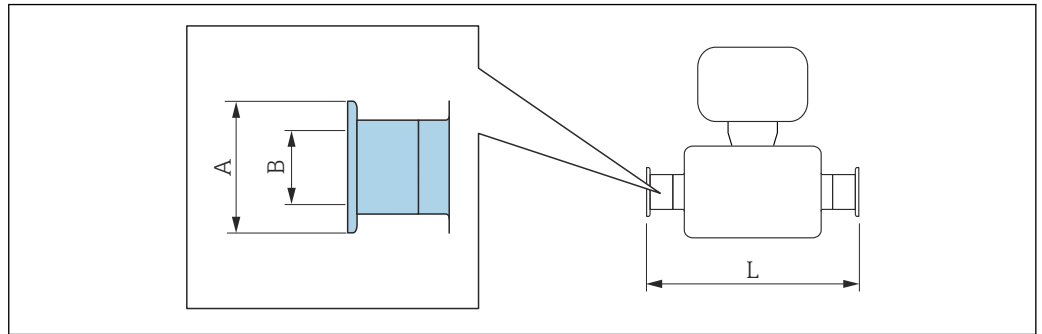

A0015625

 Length tolerance for dimension L in mm:  
+1.5 / -2.0

<b>Tri-Clamp (½"), for pipe according to DIN 11866 series C</b>				
<b>1.4404 (316/316L)</b>				
<i>Order code for "Process connection", option FDW</i>				
DN [mm]	Clamp [in]	A [mm]	B [mm]	L [mm]
8	½	25.0	9.5	367
15	½	25.0	9.5	398

3-A version available: order code for "Additional approval", option LP in conjunction with  
 $Ra_{max} = 0.76 \mu\text{m}$ : order code for "Measuring tube material", option SB, SE or  
 $Ra_{max} = 0.38 \mu\text{m}$ : order code for "Measuring tube material", option SC, SF  
 $Ra_{max} = 0.38 \mu\text{m}$  electropolished: order code for "Measuring tube material", option BC

<b>Tri-Clamp (≥ 1"), for pipe according to DIN 11866 series C</b>				
<b>1.4404 (316/316L)</b>				
<i>Order code for "Process connection", option FTS</i>				
DN [mm]	Clamp [in]	A [mm]	B [mm]	L [mm]
8	1	50.4	22.1	367
15	1	50.4	22.1	398
25	1	50.4	22.1	434
40	1½	50.4	34.8	560
50	2	63.9	47.5	720
80	3	90.9	72.9	900
100	4	118.9	97.4	1127

3-A version available: order code for "Additional approval", option LP in conjunction with  
 $Ra_{max} = 0.76 \mu\text{m}$ : order code for "Measuring tube material", option SB, SE or  
 $Ra_{max} = 0.38 \mu\text{m}$ : order code for "Measuring tube material", option SC, SF  
 $Ra_{max} = 0.38 \mu\text{m}$  electropolished: order code for "Measuring tube material", option BC

## Threaded couplings

Thread DIN 11851, DIN11864-1, SMS 1145

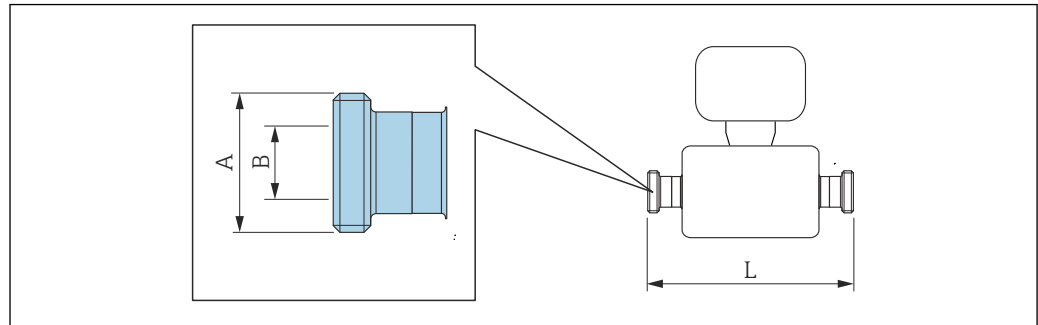

A0015628

**i** Length tolerance for dimension L in mm:  
+1.5 / -2.0

Thread DIN 11851, for pipe according to DIN11866 series A 1.4404 (316/316L) Order code for "Process connection", option FMW			
DN [mm]	A [in]	B [mm]	L [mm]
8	Rd 34 × 1/8	16	367
15	Rd 34 × 1/8	16	398
25	Rd 52 × 1/6	26	434
40	Rd 65 × 1/6	38	560
50	Rd 78 × 1/6	50	720
80	Rd 110 × 1/4	81	900
100	Rd 130 × 1/4	100	1127

3-A version available: order code for "Additional approval", option LP in conjunction with  
Ra<sub>max</sub> = 0.76 µm: order code for "Measuring tube material", option SB, SE

Thread DIN11864-1 Form A, for pipe according to DIN11866 series A 1.4404 (316/316L) Order code for "Process connection", option FLW			
DN [mm]	A [in]	B [mm]	L [mm]
8	Rd 28 × 1/8	10	367
15	Rd 34 × 1/8	16	398
25	Rd 52 × 1/8	26	434
40	Rd 65 × 1/6	38	560
50	Rd 78 × 1/6	50	720
80	Rd 110 × 1/4	81	900
100	Rd 130 × 1/4	100	1127

3-A version available: order code for "Additional approval", option LP in conjunction with  
Ra<sub>max</sub> = 0.76 µm: order code for "Measuring tube material", option SB, SE or  
Ra<sub>max</sub> = 0.38 µm: order code for "Measuring tube material", option SC, SF  
Ra<sub>max</sub> = 0.38 µm electropolished: order code for "Measuring tube material", option BC

<b>Thread SMS 1145</b> <b>1.4404 (316/316L)</b> <i>Order code for "Process connection", option SCS</i>			
DN [mm]	A [in]	B [mm]	L [mm]
8	Rd 40 × 1/6	22.6	367
15	Rd 40 × 1/6	22.6	398
25	Rd 40 × 1/6	22.6	434
40	Rd 60 × 1/6	35.6	560
50	Rd 70 × 1/6	48.6	720
80	Rd 98 × 1/6	72.9	900
100	Rd 132 × 1/6	97.6	1 127

3-A version available: order code for "Additional approval", option LP in conjunction with  
 $Ra_{max} = 0.76 \mu\text{m}$ : order code for "Measuring tube material", option SB, SE

## Thread ISO 2853

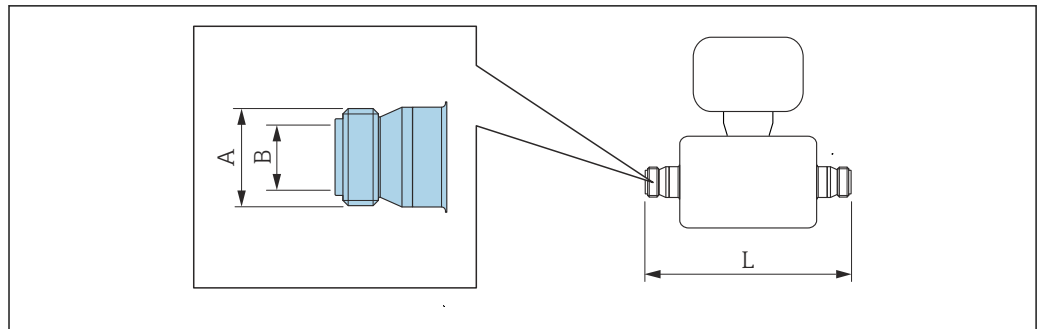

A0015623

**i** Length tolerance for dimension L in mm:  
+1.5 / -2.0

**Thread ISO 2853, for pipe according to ISO 2037  
1.4404 (316/316L)**

Order code for "Process connection", option JSF

DN [mm]	A <sup>1)</sup> [mm]	B [mm]	L [mm]
8	37.13	22.6	367
15	37.13	22.6	398
25	37.13	22.6	434
40	52.68	35.6	560
50	64.16	48.6	720
80	91.19	72.9	900
100	118.21	97.6	1 127

3-A version available: order code for "Additional approval", option LP in conjunction with  
 $Ra_{max} = 0.76 \mu\text{m}$ : order code for "Measuring tube material", option SB, SE or  
 $Ra_{max} = 0.38 \mu\text{m}$ : order code for "Measuring tube material", option SC, SF  
 $Ra_{max} = 0.38 \mu\text{m}$  electropolished: order code for "Measuring tube material", option BC

1) Max. thread diameter according to ISO 2853 Annex A

VCO

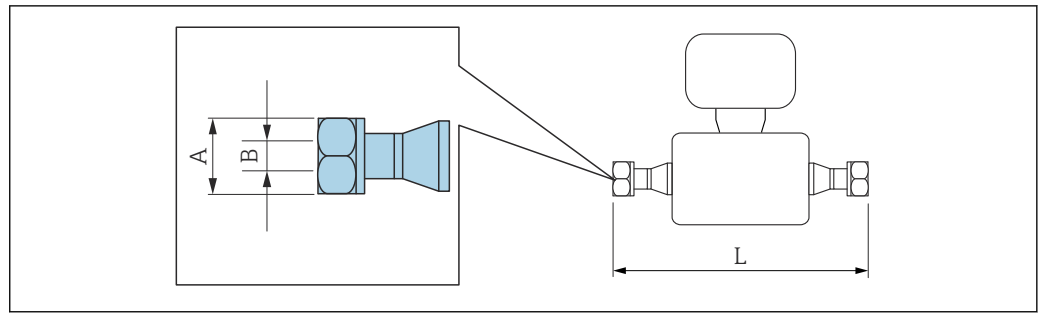

A0015624

**i** Length tolerance for dimension L in mm:  
+1.5 / -2.0

8-VCO-4 (1/2") 1.4404 (316/316L) Order code for "Process connection", option CVS			
DN [mm]	A [in]	B [mm]	L [mm]
8	AF 1	10.2	390

12-VCO-4 (3/4") 1.4404 (316/316L) Order code for "Process connection", option CWS			
DN [mm]	A [in]	B [mm]	L [mm]
15	AF 1½	15.7	430

**Accessories**

*Rupture disk/purge connections*

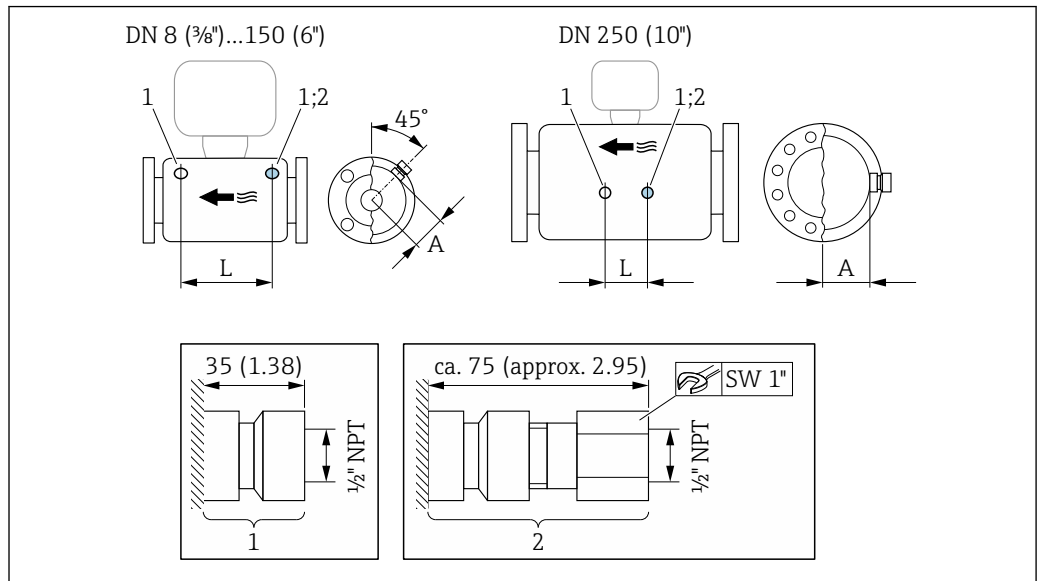

A0028914

40

- 1 Connection nipple for purge connections: order code for "Sensor options", option CH "Purge connection"
- 2 Connection nipple with rupture disk: order code for "Sensor option", option CA "Rupture disk"

DN	A	L
[mm]	[mm]	[mm]
8	62	216
15	62	220
25	62	260
40	67	310
50	79	452
80	101	560
100	120	684
150	141	880
250	182	380

*Weather protection cover*

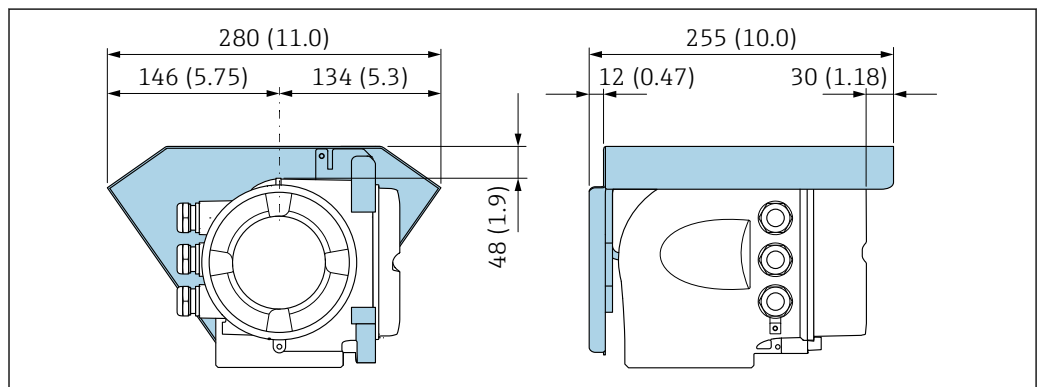

A0029553

41 Engineering unit mm (in)

Remote display and operating module DKX001

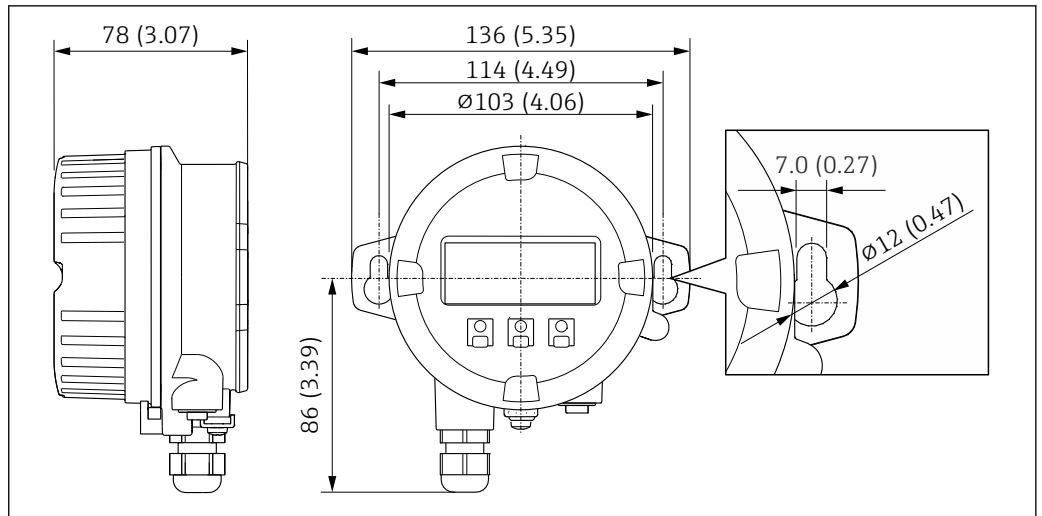

A0028921

42 Engineering unit mm (in)

External WLAN antenna

**i** The external WLAN antenna is not suitable for use in hygienic applications.

External WLAN antenna mounted on device

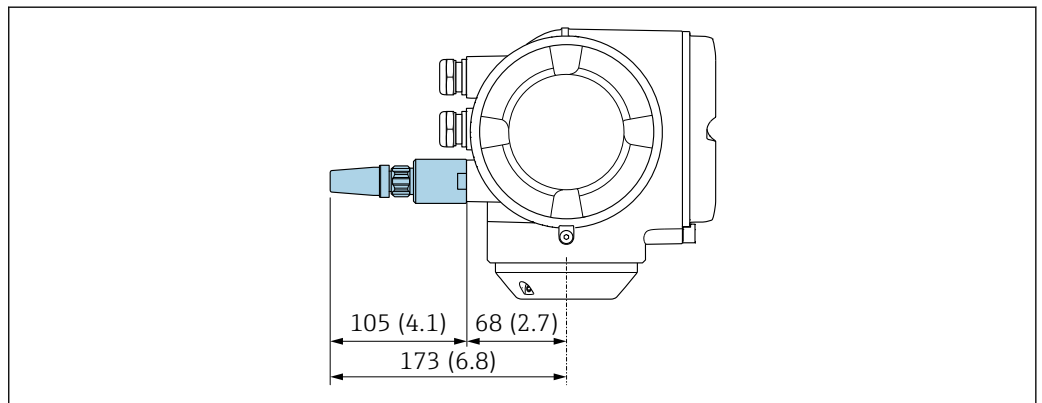

A0028923

43 Engineering unit mm (in)

External WLAN antenna mounted with cable

The external WLAN antenna can be mounted separately from the transmitter if the transmission/reception conditions at the transmitter mounting location are poor.

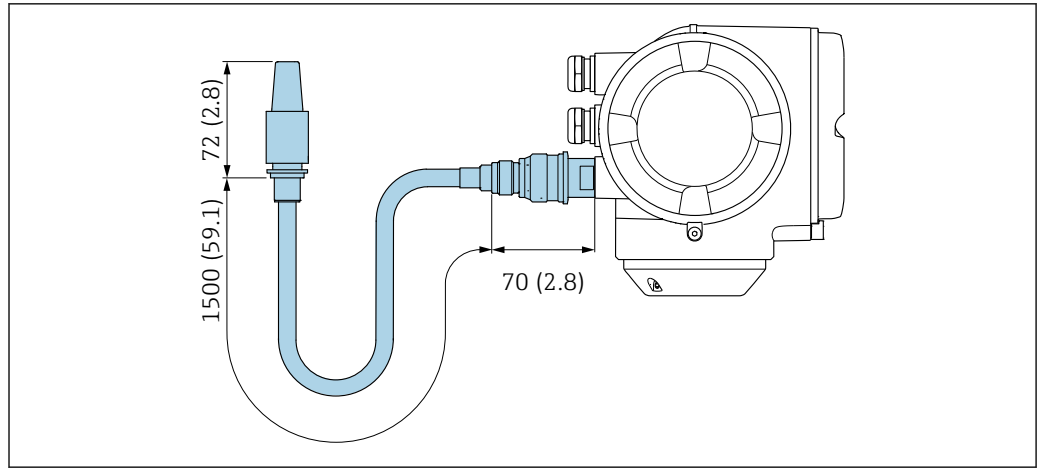

A0033597

44 Engineering unit mm (in)



Dimensions in US units

Compact version

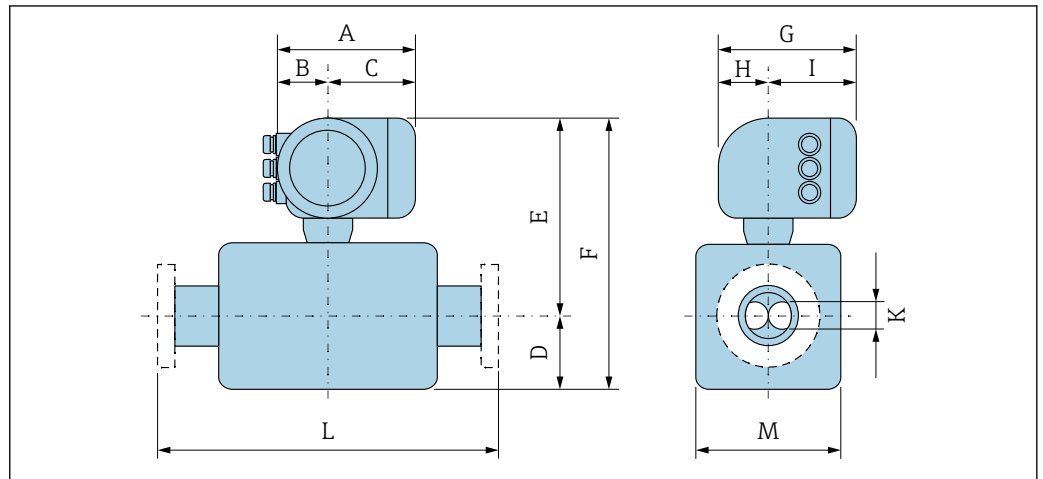

A0033786

Order code for "Housing", option A "Aluminum, coated"

DN	A <sup>1)</sup>	B <sup>1)</sup>	C	D	E <sup>2) 3)</sup>	F <sup>2) 3)</sup>	G <sup>4)</sup>	H	I <sup>4)</sup>	K	L	M
[in]	[in]	[in]	[in]	[in]	[in]	[in]	[in]	[in]	[in]	[in]	[in]	[in]
3/8	6.65	2.68	3.98	2.95	10.22	13.17	7.87	2.32	5.55	0.21	<sup>5)</sup>	2.76
1/2	6.65	2.68	3.98	2.95	10.22	13.17	7.87	2.32	5.55	0.33	<sup>5)</sup>	2.76
1	6.65	2.68	3.98	2.95 <sup>6)</sup>	10.22	13.17	7.87	2.32	5.55	0.47	<sup>5)</sup>	2.76
1 1/2	6.65	2.68	3.98	4.13	10.41	14.55	7.87	2.32	5.55	0.69	<sup>5)</sup>	3.11
2	6.65	2.68	3.98	5.55	10.81	16.36	7.87	2.32	5.55	1.02	<sup>5)</sup>	3.90
3	6.65	2.68	3.98	7.87	11.59	19.47	7.87	2.32	5.55	1.59	<sup>5)</sup>	5.47
4	6.65	2.68	3.98	10.00	12.30	22.30	7.87	2.32	5.55	2.02	<sup>5)</sup>	6.93
6	6.65	2.68	3.98	14.88	13.13	28.01	7.87	2.32	5.55	2.71	<sup>5)</sup>	8.58
10	6.65	2.68	3.98	21.57	14.86	36.44	7.87	2.32	5.55	4.03	<sup>5)</sup>	12.01

- 1) Depending on the cable gland used: values up to + 1.18 in
- 2) With order code for "Sensor option", option CG or order code for "Measuring tube material", option SD, SE, SF, TH, LA: values +2.76 in
- 3) With order code for "Measuring tube material", option TS, TT, TU: values +4.02 in
- 4) For version without local display: values - 1.18 in
- 5) Depending on the process connection
- 6) With order code for "Measuring tube material", option TT, TU: value +0.98 in

Order code for "Housing", option A "Aluminum, coated"; Ex d

DN	A <sup>1)</sup>	B <sup>1)</sup>	C	D	E <sup>2) 3)</sup>	F	G <sup>4)</sup>	H	I	K	L	M
[in]	[in]	[in]	[in]	[in]	[in]	[in]	[in]	[in]	[in]	[in]	[in]	[in]
3/8	7.40	3.35	4.06	2.95	10.26	13.21	8.54	2.28	6.26	0.21	<sup>5)</sup>	2.76
1/2	7.40	3.35	4.06	2.95	10.26	13.21	8.54	2.28	6.26	0.33	<sup>5)</sup>	2.76
1	7.40	3.35	4.06	2.95 <sup>6)</sup>	10.26	13.21	8.54	2.28	6.26	0.47	<sup>5)</sup>	2.76
1 1/2	7.40	3.35	4.06	4.13	10.43	14.57	8.54	2.28	6.26	0.69	<sup>5)</sup>	3.11
2	7.40	3.35	4.06	5.55	10.83	16.38	8.54	2.28	6.26	1.02	<sup>5)</sup>	3.90
3	7.40	3.35	4.06	7.87	11.61	19.49	8.54	2.28	6.26	1.59	<sup>5)</sup>	5.47
4	7.40	3.35	4.06	10	12.34	22.34	8.54	2.28	6.26	2.02	<sup>5)</sup>	6.93

DN	A <sup>1)</sup>	B <sup>1)</sup>	C	D	E <sup>2) 3)</sup>	F	G <sup>4)</sup>	H	I	K	L	M
[in]	[in]	[in]	[in]	[in]	[in]	[in]	[in]	[in]	[in]	[in]	[in]	[in]
6	7.40	3.35	4.06	14.88	13.17	28.05	8.54	2.28	6.26	2.71	<sup>5)</sup>	8.58
10	7.40	3.35	4.06	21.57	14.88	36.46	8.54	2.28	6.26	4.03	<sup>5)</sup>	12.01

- 1) Depending on the cable gland used: values up to + 1.18 in
- 2) With order code for "Sensor option", option CG or order code for "Measuring tube material", option SD, SE, SF, TH, LA: values +2.76 in
- 3) With order code for "Measuring tube material", option TS, TT, TU: values +4.02 in
- 4) For version without local display: values - 1.57 in
- 5) Depending on the process connection
- 6) With order code for "Measuring tube material", option TT, TU: value +0.98 in

*Order code for "Housing", option B "Stainless, hygienic"*

DN	A <sup>1)</sup>	B <sup>1)</sup>	C	D	E <sup>2) 3)</sup>	F	G <sup>4)</sup>	H	I	K	L	M
[in]	[in]	[in]	[in]	[in]	[in]	[in]	[in]	[in]	[in]	[in]	[in]	[in]
$\frac{3}{8}$	7.20	2.87	4.33	2.95	10.22	13.17	7.87	2.56	5.31	0.21	<sup>5)</sup>	2.76
$\frac{1}{2}$	7.20	2.87	4.33	2.95	10.22	13.17	7.87	2.56	5.31	0.33	<sup>5)</sup>	2.76
1	7.20	2.87	4.33	2.95 <sup>6)</sup>	10.22	13.17	7.87	2.56	5.31	0.47	<sup>5)</sup>	2.76
1½	7.20	2.87	4.33	4.13	10.41	14.55	7.87	2.56	5.31	0.69	<sup>5)</sup>	3.11
2	7.20	2.87	4.33	5.55	10.81	16.36	7.87	2.56	5.31	1.02	<sup>5)</sup>	3.90
3	7.20	2.87	4.33	7.87	11.59	19.47	7.87	2.56	5.31	1.59	<sup>5)</sup>	5.47
4	7.20	2.87	4.33	10.00	12.30	22.30	7.87	2.56	5.31	2.02	<sup>5)</sup>	6.93
6	7.20	2.87	4.33	14.88	13.13	28.01	7.87	2.56	5.31	2.71	<sup>5)</sup>	8.58
10	7.20	2.87	4.33	21.57	14.86	36.44	7.87	2.56	5.31	4.03	<sup>5)</sup>	12.01

- 1) Depending on the cable gland used: values up to + 1.18 in
- 2) With order code for "Sensor option", option CG or order code for "Measuring tube material", option SD, SE, SF, TH, LA: values +2.76 in
- 3) With order code for "Measuring tube material", option TS, TT, TU: values +4.02 in
- 4) For version without local display: values - 0.51 in
- 5) Depending on the process connection
- 6) With order code for "Measuring tube material", option TT, TU: value +0.98 in

*Order code for "Housing", option L "Cast, stainless"*

DN	A <sup>1)</sup>	B <sup>1)</sup>	C	D	E <sup>2) 3)</sup>	F	G	H	I	K	L	M
[in]	[in]	[in]	[in]	[in]	[in]	[in]	[in]	[in]	[in]	[in]	[in]	[in]
$\frac{3}{8}$	7.32	3.35	3.98	2.95	10.24	13.19	8.54	2.36	6.18	0.21	<sup>4)</sup>	2.76
$\frac{1}{2}$	7.32	3.35	3.98	2.95	10.24	13.19	8.54	2.36	6.18	0.33	<sup>4)</sup>	2.76
1	7.32	3.35	3.98	2.95 <sup>5)</sup>	10.24	13.19	8.54	2.36	6.18	0.47	<sup>4)</sup>	2.76
1½	7.32	3.35	3.98	4.13	10.41	14.55	8.54	2.36	6.18	0.69	<sup>4)</sup>	3.11
2	7.32	3.35	3.98	5.55	10.81	16.36	8.54	2.36	6.18	1.02	<sup>4)</sup>	3.90
3	7.32	3.35	3.98	7.87	11.59	19.47	8.54	2.36	6.18	1.59	<sup>4)</sup>	5.47
4	7.32	3.35	3.98	10	12.32	22.32	8.54	2.36	6.18	2.02	<sup>4)</sup>	6.93

DN	A <sup>1)</sup>	B <sup>1)</sup>	C	D	E <sup>2) 3)</sup>	F	G	H	I	K	L	M
[in]	[in]	[in]	[in]	[in]	[in]	[in]	[in]	[in]	[in]	[in]	[in]	[in]
6	7.32	3.35	3.98	14.88	13.15	28.03	8.54	2.36	6.18	2.71	<sup>4)</sup>	8.58
10	7.32	3.35	3.98	21.57	14.86	36.44	8.54	2.36	6.18	4.03	<sup>4)</sup>	12.01

- 1) Depending on the cable gland used: values up to + 1.18 in
- 2) With order code for "Sensor option", option CG or order code for "Measuring tube material", option SD, SE, SF, TH, LA: values +2.76 in
- 3) With order code for "Measuring tube material", option TS, TT, TU: values +4.02 in
- 4) Depending on the process connection
- 5) With order code for "Measuring tube material", option TT, TU: value +0.98 in

Flange connections

Fixed flange ASME B16.5

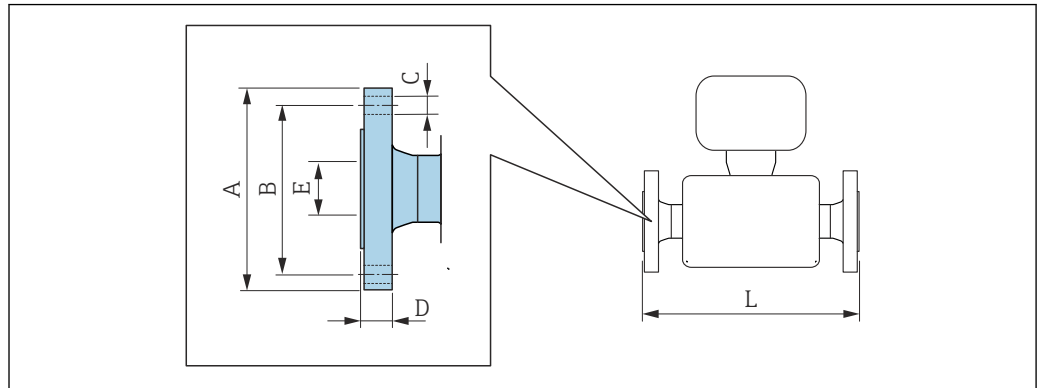

A0015621

- i** Length tolerance for dimension L in inch:
- DN ≤ 4": +0.06 / -0.08
  - DN ≥ 6": ±0.14

Flange according to ASME B16.5: Class 150 1.4404 (F316/F316L): order code for "Process connection", option AAS Alloy C22: order code for "Process connection", option AAC						
DN [in]	A [in]	B [in]	C [in]	D [in]	E [in]	L [in]
3/8 <sup>1)</sup>	3.54	2.37	4 × Ø0.62	0.44	0.62	14.57
1/2	3.54	2.37	4 × Ø0.62	0.44	0.62	15.91
1	4.33	3.13	4 × Ø0.62	0.56	1.05	17.32
1 1/2	4.92	3.87	4 × Ø0.63	0.63	1.61	21.65
2	5.91	4.75	4 × Ø0.75	0.75	2.07	28.15
3	7.48	6.00	4 × Ø0.75	0.94	3.07	33.07
4	9.06	7.50	8 × Ø0.75	0.94	4.03	44.37
6	11.02	9.50	8 × Ø0.88	1	6.07	55.04
10	15.94	14.25	12 × Ø1.0	1.19	10.02	72.13

Surface roughness (flange): Ra 126 to 248 µin

1) DN 3/8" with DN 1/2" flanges as standard

Flange according to ASME B16.5: Class 150 with reduction in nominal diameter 1.4404 (F316/F316L)								
DN [in]	Reduction to DN [in]	Order code for "Process connection", option	A [in]	B [in]	C [in]	D [in]	E [in]	L [in]
2	1 1/2	AHS	5.91	4.75	4 × Ø0.75	0.75	2.07	21.65
3	2	AJS	7.48	6	4 × Ø0.75	0.94	3.07	28.35
4	3	ALS	9.06	7.5	8 × Ø0.75	0.94	4.03	34.41
6	4	ANS	11.02	9.5	8 × Ø0.88	1	6.07	45.94
8	6	APS	13.58	11.75	8 × Ø0.88	1.14	7.98	57.52

Surface roughness (flange): Ra 126 to 248 µin

**Flange according to ASME B16.5: Class 300**  
**1.4404 (F316/F316L):** order code for "Process connection", option **ABS**  
**Alloy C22:** order code for "Process connection", option **ABC**

DN [in]	A [in]	B [in]	C [in]	D [in]	E [in]	L [in]
$\frac{3}{8}$ <sup>1)</sup>	3.74	2.63	4 × Ø0.62	0.56	0.62	14.57
$\frac{1}{2}$	3.74	2.63	4 × Ø0.62	0.56	0.62	15.91
1	4.92	3.50	4 × Ø0.75	0.69	1.05	17.32
1½	6.10	4.50	4 × Ø0.88	0.81	1.61	21.65
2	6.50	5.00	8 × Ø0.75	0.88	2.07	28.15
3	8.27	6.63	8 × Ø0.88	1.12	3.07	33.07
4	10.04	7.87	8 × Ø0.88	1.25	4.03	44.37
6	12.6	10.63	12 × Ø0.88	1.44	6.07	55.79
10	17.52	15.25	16 × Ø1.12	1.87	10.02	73.35

Surface roughness (flange): Ra 126 to 248 µin

1) DN  $\frac{3}{8}$ " with DN  $\frac{1}{2}$ " flanges as standard

**Flange according to ASME B16.5: Class 300 with reduction in nominal diameter**  
**1.4404 (F316/F316L)**

DN [in]	Reduction to DN [in]	Order code for "Process connection", option	A [in]	B [in]	C [in]	D [in]	E [in]	L [in]
2	1½	AIS	6.5	5	8 × Ø0.75	0.88	2.07	24.21
3	2	AKS	8.27	6.63	8 × Ø0.88	1.12	3.07	28.82
4	3	AMS	10.04	7.87	8 × Ø0.88	1.25	4.03	35.2
6	4	AOS	12.6	10.63	12 × Ø0.88	1.44	6.07	46.73
8	6	AQS	14.96	13	12 × Ø1	1.64	7.98	57.52

Surface roughness (flange): Ra 126 to 248 µin

**Flange according to ASME B16.5: Class 600**  
**1.4404 (F316/F316L):** order code for "Process connection", option **ACS**  
**Alloy C22:** order code for "Process connection", option **ACC**

DN [in]	A [in]	B [in]	C [in]	D [in]	E [in]	L [in]
$\frac{3}{8}$ <sup>1)</sup>	3.74	2.63	4 × Ø0.62	0.81	0.55	15.75
$\frac{1}{2}$	3.74	2.63	4 × Ø0.62	0.81	0.55	16.54
1	4.92	3.50	4 × Ø0.75	0.94	0.96	19.29
1½	6.10	4.50	4 × Ø0.88	1.13	1.5	23.62
2	6.50	5.00	8 × Ø0.75	1.25	1.94	29.21
3	8.27	6.63	8 × Ø0.88	1.5	2.9	35.43
4	10.83	8.50	8 × Ø1.00	1.91	3.83	45.55
6	13.98	11.50	12 × Ø1.12	1.88	6.07	57.76
10	20.08	17.00	16 × Ø1.38	2.75	10.02	76.61

Surface roughness (flange): Ra 126 to 248 µin

1) DN  $\frac{3}{8}$ " with DN  $\frac{1}{2}$ " flanges as standard

## Lap joint flange ASME B16.5

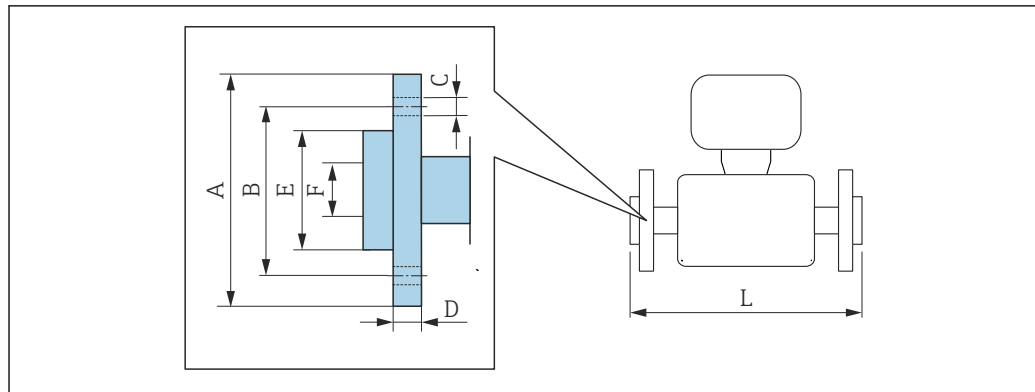

A002221

**i** Length tolerance for dimension L in inch:  
+0.06 / -0.08

Lap joint flange according to ASME B16.5: Class 150								
1.4301 (F304), wetted parts Alloy C22								
Order code for "Process connection", option ADC								
DN [in]	A [in]	B [in]	C [in]	D [in]	E [in]	F [in]	L [in]	L <sub>diff</sub> <sup>1)</sup> [in]
$\frac{3}{8}$ <sup>2)</sup>	3.54	2.37	4 × Ø 0.62	0.59	1.38	0.62	14.57	0
$\frac{1}{2}$	3.54	2.37	4 × Ø 0.62	0.59	1.38	0.62	15.91	0
1	4.33	3.13	4 × Ø 0.62	0.63	2	1.05	17.32	0
1½	4.92	3.87	4 × Ø 0.62	0.63	2.88	1.61	21.65	0
2	5.91	4.75	4 × Ø 0.75	0.75	3.62	2.07	28.15	0
3	7.48	6.00	4 × Ø 0.75	0.88	5	3.07	33.07	0
4	9.06	7.50	8 × Ø 0.75	1.02	6.19	4.03	44.37	0

Surface roughness (flange): Ra 126 to 492 µin

- 1) Difference to installed length of the welding neck flange (order code for "Process connection", option AAC)  
2) DN  $\frac{3}{8}$ " with DN  $\frac{1}{2}$ " flanges as standard

Lap joint flange according to ASME B16.5: Class 300								
1.4301 (F304), wetted parts Alloy C22								
Order code for "Process connection", option AEC								
DN [in]	A [in]	B [in]	C [in]	D [in]	E [in]	F [in]	L [in]	L <sub>diff</sub> <sup>1)</sup> [in]
$\frac{3}{8}$ <sup>2)</sup>	3.74	2.63	4 × Ø 0.62	0.65	1.38	0.62	14.8	+0.23
$\frac{1}{2}$	3.74	2.63	4 × Ø 0.62	0.65	1.38	0.62	15.98	+0.07
1	4.92	3.50	4 × Ø 0.75	0.83	2	1.05	17.72	+0.40
1½	6.10	4.50	4 × Ø 0.88	0.91	2.88	1.61	22.2	+0.55
2	6.50	5.00	8 × Ø 0.75	1	3.62	2.07	28.23	+0.08
3	8.27	6.63	8 × Ø 0.88	1.22	5	3.07	33.57	+0.50
4	10.04	7.87	8 × Ø 0.88	1.26	6.19	4.03	44.84	+0.47

Surface roughness (flange): Ra 126 to 492 µin

- 1) Difference to installed length of the welding neck flange (order code for "Process connection", option AAC)  
2) DN  $\frac{3}{8}$ " with DN  $\frac{1}{2}$ " flanges as standard

Lap joint flange according to ASME B16.5, Class 600 1.4301 (F304), wetted parts Alloy C22 Order code for "Process connection", option AFC								
DN [in]	A [in]	B [in]	C [in]	D [in]	E [in]	F [in]	L [in]	L <sub>diff</sub> <sup>1)</sup> [in]
$\frac{3}{8}$ <sup>2)</sup>	3.74	2.63	4 × Ø 0.62	0.67	1.38	0.55	15.75	0
$\frac{1}{2}$	3.74	2.63	4 × Ø 0.62	0.67	1.38	0.55	16.54	0
1	4.92	3.50	4 × Ø 0.75	0.85	2	0.96	19.29	0
1½	6.10	4.50	4 × Ø 0.88	0.98	2.88	1.5	23.62	0
2	6.50	5.00	8 × Ø 0.75	1.1	3.62	1.94	29.21	0
3	8.27	6.63	8 × Ø 0.88	1.38	5	2.9	35.43	0
4	10.83	8.50	8 × Ø 1	1.73	6.19	3.83	45.94	+0.39
Surface roughness (flange): Ra 126 to 492 µin								

- 1) Difference to installed length of the welding neck flange (order code for "Process connection", option AAC)
- 2) DN  $\frac{3}{8}$ " with DN  $\frac{1}{2}$ " flanges as standard

## Clamp connections

### Tri-Clamp

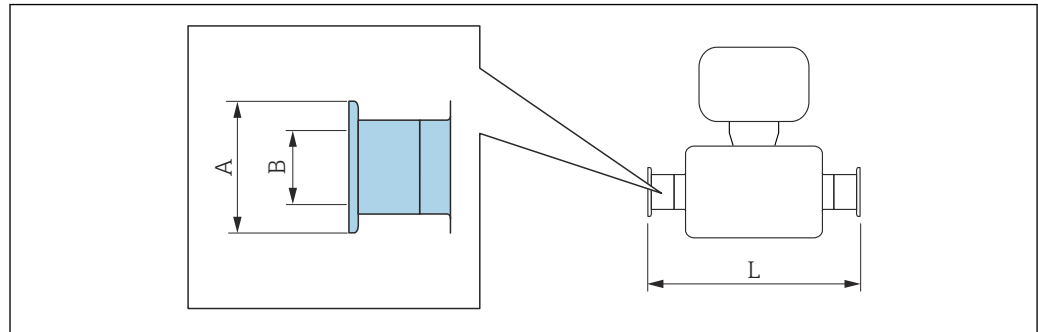

A0015625

**i** Length tolerance for dimension L in inch:  
+0.06 / -0.08

Tri-Clamp (½"), DIN 11866 series C 1.4404 (316/316L) Order code for "Process connection", option FDW				
DN [in]	Clamp [in]	A [in]	B [in]	L [in]
¾	½	0.98	0.37	14.4
½	½	0.98	0.37	15.7

3-A version available: order code for "Additional approval", option LP in conjunction with  
 $Ra_{max} = 30 \mu\text{in}$ : order code for "Measuring tube material", option SB, SE or  
 $Ra_{max} = 15 \mu\text{in}$ : order code for "Measuring tube material", option SC, SF  
 $Ra_{max} = 15 \mu\text{in}$  electropolished: order code for "Measuring tube material", option BC

Tri-Clamp ( $\geq 1"$ ), DIN 11866 series C 1.4404 (316/316L) Order code for "Process connection", option FTS				
DN [in]	Clamp [in]	A [in]	B [in]	L [in]
¾	1	1.98	0.87	14.4
½	1	1.98	0.87	15.7
1	1	1.98	0.87	17.1
1½	1½	1.98	1.37	22.0
2	2	2.52	1.87	28.3
3	3	3.58	2.87	35.4
4	4	4.68	3.83	44.4

3-A version available: order code for "Additional approval", option LP in conjunction with  
 $Ra_{max} = 30 \mu\text{in}$ : order code for "Measuring tube material", option SB, SE or  
 $Ra_{max} = 15 \mu\text{in}$ : order code for "Measuring tube material", option SC, SF  
 $Ra_{max} = 15 \mu\text{in}$  electropolished: order code for "Measuring tube material", option BC



**Threaded couplings**

Thread SMS 1145

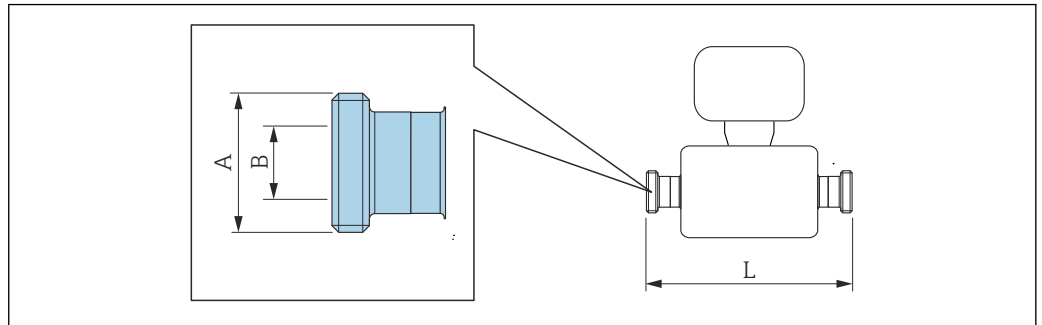

A0015628

**i** Length tolerance for dimension L in inch:  
+0.06 / -0.08

Thread SMS 1145 1.4404 (316/316L) Order code for "Process connection", option SCS			
DN [in]	A [in]	B [in]	L [in]
3/8	Rd 40 × 1/6	0.89	14.45
1/2	Rd 40 × 1/6	0.89	15.67
1	Rd 40 × 1/6	0.89	17.09
1 1/2	Rd 60 × 1/6	1.4	22.05
2	Rd 70 × 1/6	1.91	28.35
3	Rd 98 × 1/6	2.87	35.43
4	Rd 132 × 1/6	3.84	44.37

3-A version available: order code for "Additional approval", option LP in conjunction with  
 $Ra_{max} = 30 \mu\text{in}$ : order code for "Measuring tube material", option SB, SE

VCO

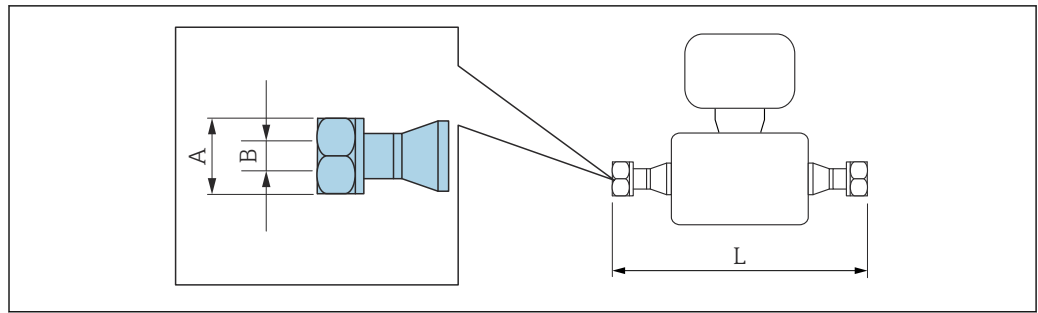

A0015624

**i** Length tolerance for dimension L in inch:  
+0.06 / -0.08

8-VCO-4 (1/2") 1.4404 (316/316L) Order code for "Process connection", option CVS			
DN [in]	A [in]	B [in]	L [in]
3/8	AF 1	0.4	15.35

12-VCO-4 (3/4") 1.4404 (316/316L) Order code for "Process connection", option CWS			
DN [in]	A [in]	B [in]	L [in]
1/2	AF 1 1/2	0.62	16.93

### Accessories

Rupture disk/purge connections

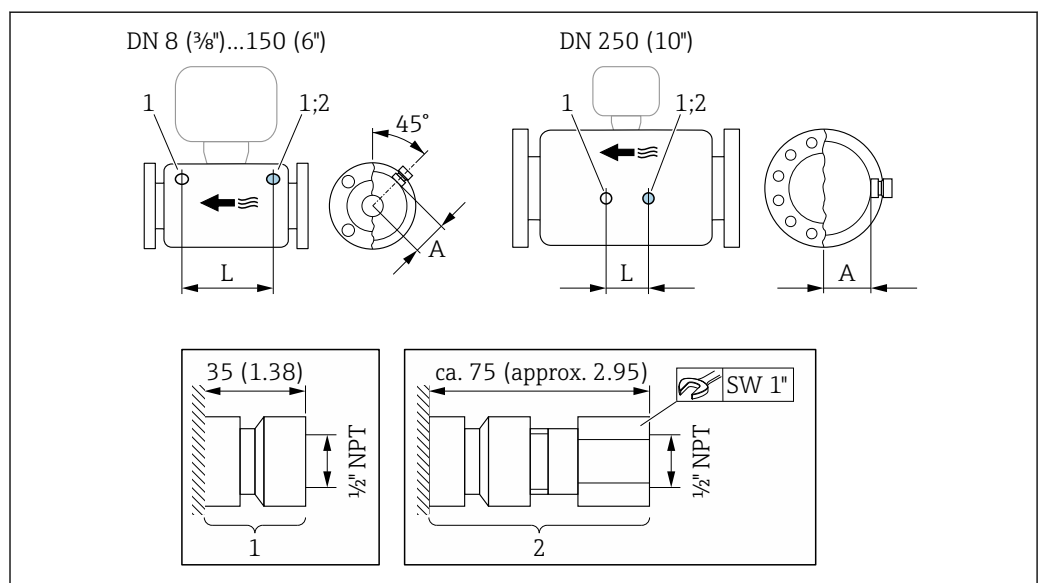

A0028914

- 1 Connection nipple for purge connections: order code for "Sensor options", option CH "Purge connection"
- 2 Connection nipple with rupture disk: order code for "Sensor option", option CA "Rupture disk"

DN	A	L
[in]	[in]	[in]
3/8	2.44	8.50
1/2	2.44	8.66
1	2.44	10.24
1 1/2	2.64	12.20
2	3.11	17.78
3	3.98	22.0
4	4.72	27.0
6	5.55	34.6
10	7.17	14.96

Weather protection cover

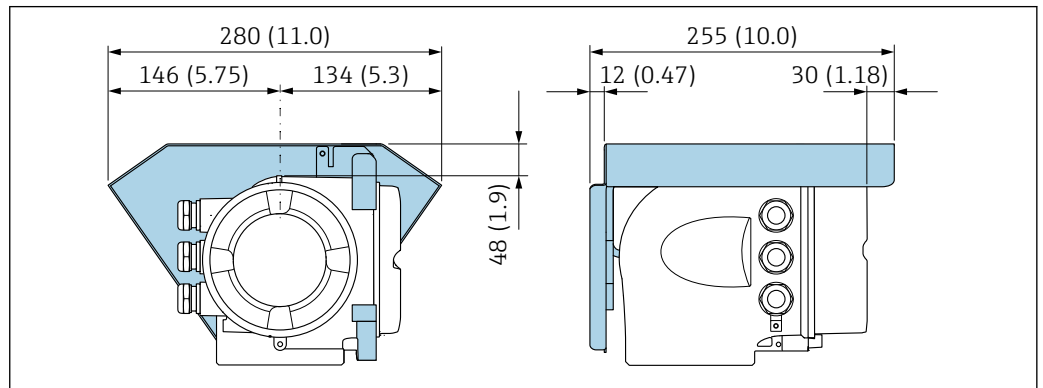

45 Engineering unit mm (in)

Remote display and operating module DKX001

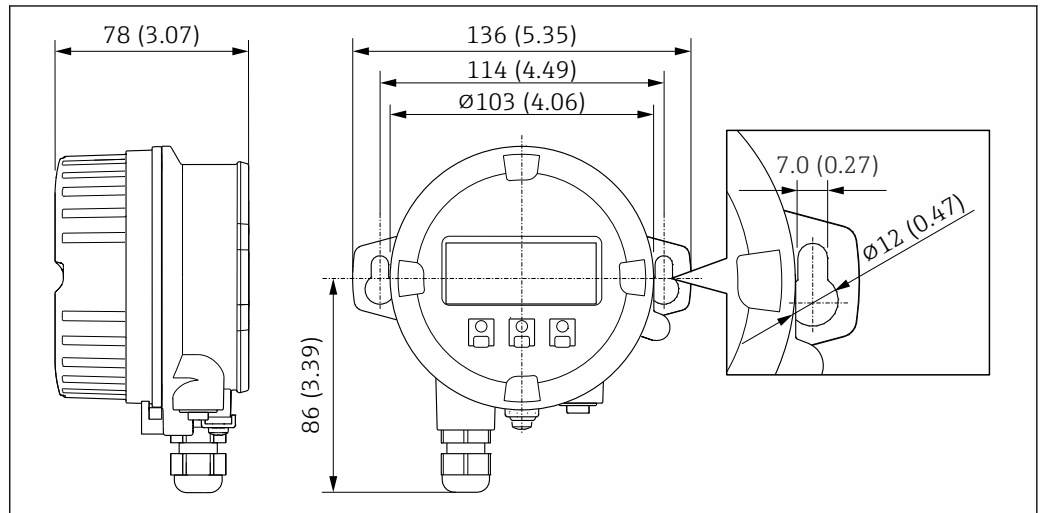

46 Engineering unit mm (in)

External WLAN antenna

**i** The external WLAN antenna is not suitable for use in hygienic applications.

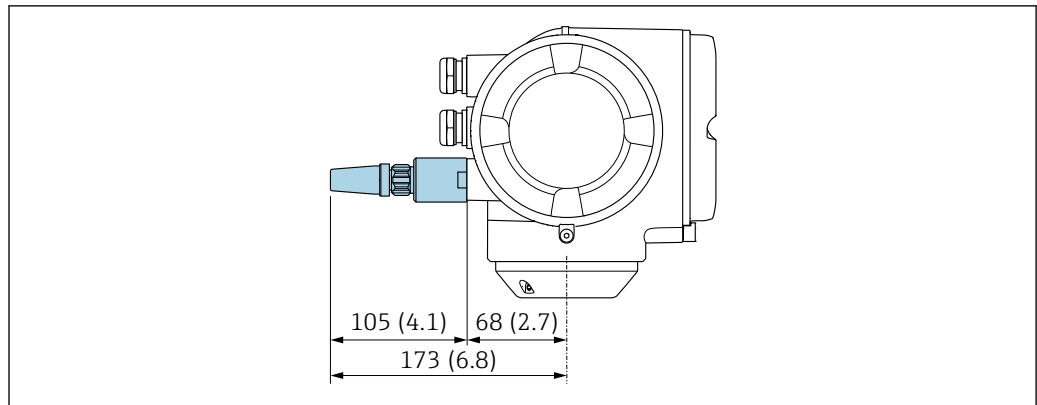
*External WLAN antenna mounted on device*

A0028923

47 Engineering unit mm (in)

*External WLAN antenna mounted with cable*

The external WLAN antenna can be mounted separately from the transmitter if the transmission/reception conditions at the transmitter mounting location are poor.

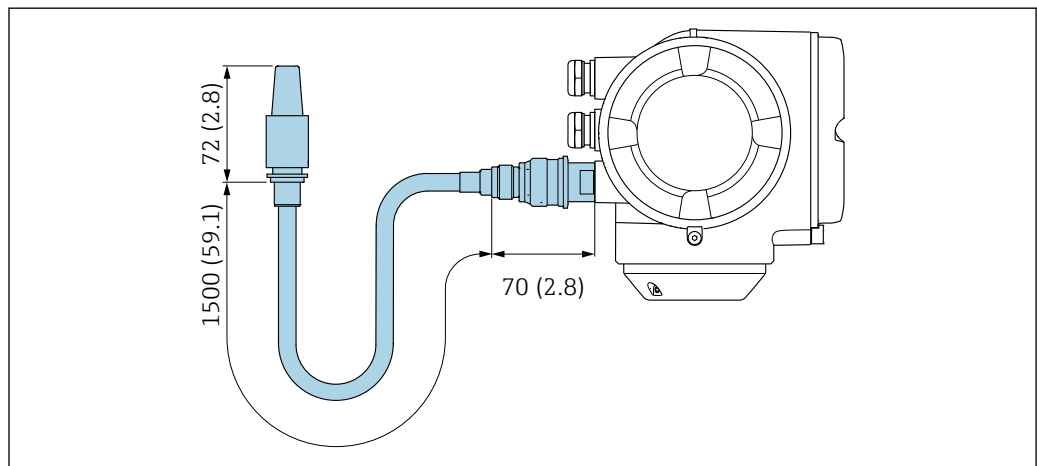

A0033597

48 Engineering unit mm (in)

**Weight**

All values (weight exclusive of packaging material) refer to devices with EN/DIN PN 40 flanges. Weight specifications including transmitter as per order code for "Housing", option A "Aluminum, coated".

Different values due to different transmitter versions:

- Transmitter version for the hazardous area  
(Order code for "Housing", option A "Aluminum, coated"; Ex d): +2 kg (+4.4 lbs)
- Cast transmitter version, stainless  
(Order code for "Housing", option L "Cast, stainless"): +6 kg (+13 lbs)
- Transmitter version for hygienic area  
(Order code for "Housing", option B "Stainless, hygienic"): +0.2 kg (+0.44 lbs)

**Weight in SI units**

DN [mm]	Weight [kg]
8	11
15	12
25	14
40	19
50	30

DN [mm]	Weight [kg]
80	55
100	96
150	154
250	400

**Weight in US units**

DN [in]	Weight [lbs]
3/8	24
1/2	26
1	31
1 1/2	42
2	66
3	121
4	212
6	340
10	882

---

**Materials**

**Transmitter housing**

Order code for "Housing":

- Option **A** "Aluminum, coated": aluminum, AlSi10Mg, coated
- Option **B** "Stainless, hygienic": stainless steel, 1.4404 (316L)
- Option **L** "Cast, stainless": cast, stainless steel, 1.4409 (CF3M) similar to 316L

*Window material*

Order code for "Housing":

- Option **A** "Aluminum, coated": glass
- Option **B** "Stainless, hygienic": polycarbonate
- Option **L** "Cast, stainless": glass

*Seals*

Order code for "Housing":

- Option **B** "Stainless, hygienic": EPDM and silicone

### Cable entries/cable glands

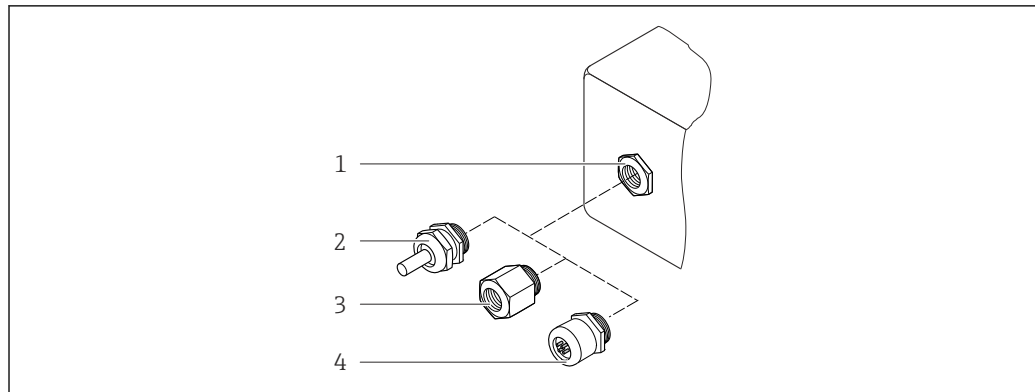

A0028352

49 Possible cable entries/cable glands

- 1 Female thread M20 × 1.5
- 2 Cable gland M20 × 1.5
- 3 Adapter for cable entry with female thread G ½" or NPT ½"
- 4 Device plug

Order code for "Housing", option A "Aluminum, coated"

The various cable entries are suitable for hazardous and non-hazardous areas.

Cable entry/cable gland	Material
Compression fitting M20 × 1.5	Non-Ex: plastic
	Z2, D2, Ex d/de: brass with plastic
Adapter for cable entry with female thread G ½"	Nickel-plated brass
Adapter for cable entry with female thread NPT ½"	

Order code for "Housing", option B "Stainless, hygienic"

The various cable entries are suitable for hazardous and non-hazardous areas.

Cable entry/cable gland	Material
Cable gland M20 × 1.5	Plastic
Adapter for cable entry with female thread G ½"	Nickel-plated brass
Adapter for cable entry with female thread NPT ½"	

Order code for "Housing", option L "Cast, stainless"

The various cable entries are suitable for hazardous and non-hazardous areas.

Cable entry/cable gland	Material
Cable gland M20 × 1.5	Stainless steel, 1.4404 (316L)
Adapter for cable entry with female thread G ½"	
Adapter for cable entry with female thread NPT ½"	

### Device plug

Electrical connection	Material
Plug M12x1	<ul style="list-style-type: none"> <li>■ Socket: Stainless steel, 1.4404 (316L)</li> <li>■ Contact housing: Polyamide</li> <li>■ Contacts: Gold-plated brass</li> </ul>

### Sensor housing



The material of the sensor housing depends on the option selected in the order code for "Measuring tube mat., wetted surface".

Order code for "Measuring tube mat., wetted surface"	Material
Option HA, SA, SD, TH	<ul style="list-style-type: none"> <li>▪ Acid and alkali-resistant outer surface</li> <li>▪ Stainless steel 1.4301 (304)</li> </ul> With order code for "Sensor option", option <b>CC</b> "316L Sensor housing": stainless steel, 1.4404 (316L)
Option SB, SC, SE, SF	<ul style="list-style-type: none"> <li>▪ Acid and alkali-resistant outer surface</li> <li>▪ Stainless steel 1.4301 (304)</li> </ul>
Option TS, TT, TU, LA	<ul style="list-style-type: none"> <li>▪ Acid and alkali-resistant outer surface</li> <li>▪ Stainless steel, 1.4404 (316L)</li> </ul>

### Measuring tubes

- DN 8 to 100 (3/8 to 4"): stainless steel, 1.4539 (904L);  
Manifold: stainless steel, 1.4404 (316/316L)
- DN 150 (6"), DN 250 (10"): stainless steel, 1.4404 (316/316L);  
Manifold: stainless steel, 1.4404 (316/316L)
- DN 8 to 250 (3/8 to 10"): Alloy C22, 2.4602 (UNS N06022);  
Manifold: Alloy C22, 2.4602 (UNS N06022)

#### High-temperature version

DN 15 (1/2"), 25 (1"), 50 to 250 (2 to 10"):

- DN 15 to 100 (1/2 to 4"): stainless steel, 1.4539 (904L)
- DN 150 (6"), 250 (10"): stainless steel, 1.4404 (316/316L)
- DN 15 to 250 (1/2 to 10"): Alloy C22, 2.4602 (UNS N06022)

### Process connections

- Flanges according to EN 1092-1 (DIN2501) / according to ASME B 16.5 / as per JIS B2220:
  - Stainless steel, 1.4404 (F316/F316L)
  - Alloy C22, 2.4602 (UNS N06022)
  - Lap joint flanges: stainless steel, 1.4301 (F304); wetted parts Alloy C22
- All other process connections:  
Stainless steel, 1.4404 (316/316L)

#### High-temperature version

Flanges according to EN 1092-1 (DIN2501) / according to ASME B 16.5 / as per JIS B2220:

- DN 15 to 250 (1/2 to 10"): stainless steel, 1.4404 (316/316L)
- DN 15 to 250 (1/2 to 10"): Alloy C22, 2.4602 (UNS N06022)



Available process connections → 108

### Seals

Welded process connections without internal seals

### Accessories

#### Protective cover

Stainless steel, 1.4404 (316L)

#### External WLAN antenna

- Antenna: ASA plastic (acrylic ester-styrene-acrylonitrile) and nickel-plated brass
- Adapter: Stainless steel and nickel-plated brass
- Cable: Polyethylene
- Plug: Nickel-plated brass
- Angle bracket: Stainless steel

---

**Process connections**

- Fixed flange connections:
  - EN 1092-1 (DIN 2501) flange
  - EN 1092-1 (DIN 2512N) flange
  - Namur lengths in accordance with NE 132
  - ASME B16.5 flange
  - JIS B2220 flange
  - DIN 11864-2 Form A flange, DIN 11866 series A, flange with notch
- Clamp connections:
  - Tri-Clamp (OD tubes), DIN 11866 series C
- Thread:
  - DIN 11851 thread, DIN 11866 series A
  - SMS 1145 thread
  - ISO 2853 thread, ISO 2037
  - DIN 11864-1 Form A thread, DIN 11866 series A
- VCO connections:
  - 8-VCO-4
  - 12-VCO-4



Process connection materials →  107

---

**Surface roughness**

All data refer to parts in contact with the medium. The following surface roughness categories can be ordered.

- Not polished
- $Ra_{max} = 0.76 \mu\text{m}$  (30  $\mu\text{in}$ )
- $Ra_{max} = 0.38 \mu\text{m}$  (15  $\mu\text{in}$ )
- $Ra_{max} = 0.38 \mu\text{m}$  (15  $\mu\text{in}$ ) electropolished



## Operability

### Operating concept

#### Operator-oriented menu structure for user-specific tasks

- Commissioning
- Operation
- Diagnostics
- Expert level

#### Fast and safe commissioning

- Guided menus ("Make-it-run" wizards) for applications
- Menu guidance with brief descriptions of the individual parameter functions
- Access to the device via Web server
- WLAN access to the device via mobile handheld terminal, tablet or smart phone

#### Reliable operation

- Operation in local language
- Uniform operating philosophy applied to device and operating tools
- If replacing electronic modules, transfer the device configuration via the integrated memory (HistoROM backup) which contains the process and measuring device data and the event logbook. No need to reconfigure.

#### Efficient diagnostic behavior increases measurement availability

- Troubleshooting measures can be called up via the device and in the operating tools
- Diverse simulation options, logbook for events that occur and optional line recorder functions

### Languages

Can be operated in the following languages:

- Via local operation  
English, German, French, Spanish, Italian, Dutch, Portuguese, Polish, Russian, Turkish, Chinese, Japanese, Korean, Vietnamese, Czech, Swedish
- Via Web browser  
English, German, French, Spanish, Italian, Dutch, Portuguese, Polish, Russian, Turkish, Chinese, Japanese, Vietnamese, Czech, Swedish
- Via "FieldCare", "DeviceCare" operating tool: English, German, French, Spanish, Italian, Chinese, Japanese

### Local operation

#### Via display module

Equipment:

- Order code for "Display; operation", option F "4-line, illuminated, graphic display; touch control"
- Order code for "Display; operation", option G "4-line, illuminated, graphic display; touch control + WLAN"



Information about WLAN interface → 117

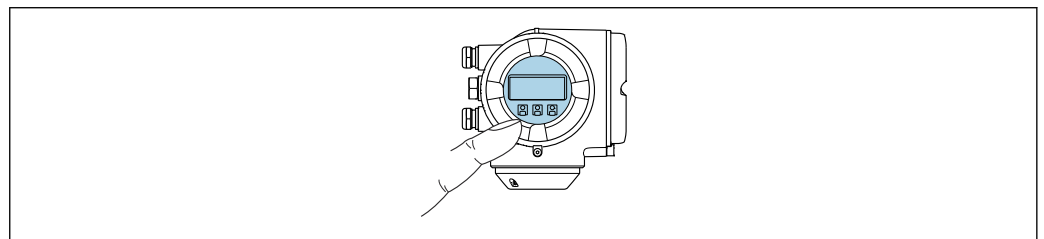

50 Operation with touch control

#### Display elements

- 4-line, illuminated, graphic display
- White background lighting; switches to red in event of device errors
- Format for displaying measured variables and status variables can be individually configured
- Permitted ambient temperature for the display: -20 to +60 °C (-4 to +140 °F)  
The readability of the display may be impaired at temperatures outside the temperature range.

*Operating elements*

- External operation via touch control (3 optical keys) without opening the housing: ☒, ☑, ☒
- Operating elements also accessible in the various zones of the hazardous area

**Via remote display and operating module DKX001**

- i** The remote display and operating module DKX001 is available as an optional extra → ☒ 128.
- The remote display and operating module DKX001 is only available for the following housing versions, order code for "Housing":
    - Option A "Aluminum, coated"
    - Option L "Cast, stainless"
  - The measuring device is always supplied with a dummy cover when the remote display and operating module DKX001 is ordered directly with the measuring device. Display or operation at the transmitter is not possible in this case.
  - If ordered subsequently, the remote display and operating module DKX001 may not be connected at the same time as the existing measuring device display module. Only one display or operation unit may be connected to the transmitter at any one time.

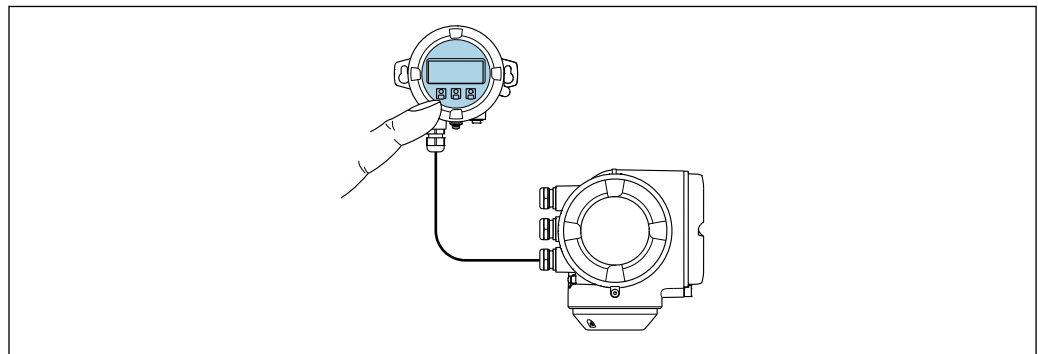

A0026786

☒ 51 Operation via remote display and operating module DKX001

*Display and operating elements*

The display and operating elements correspond to those of the display module → ☒ 109.

*Housing material*

The housing material of the display and operating module DKX001 depends on the choice of transmitter housing material.

Transmitter housing		Remote display and operating module
Order code for "Housing"	Material	Material
Option A "Aluminum, coated"	AlSi10Mg, coated	AlSi10Mg, coated
Option L "Cast, stainless"	Cast stainless steel, 1.4409 (CF3M) similar to 316L	1.4409 (CF3M)

*Cable entry*

Corresponds to the choice of transmitter housing, order code for "Electrical connection".

*Connecting cable*

→ ☒ 50

*Dimensions*

→ ☒ 91

**Remote operation****Via HART protocol**

This communication interface is available in device versions with a HART output.

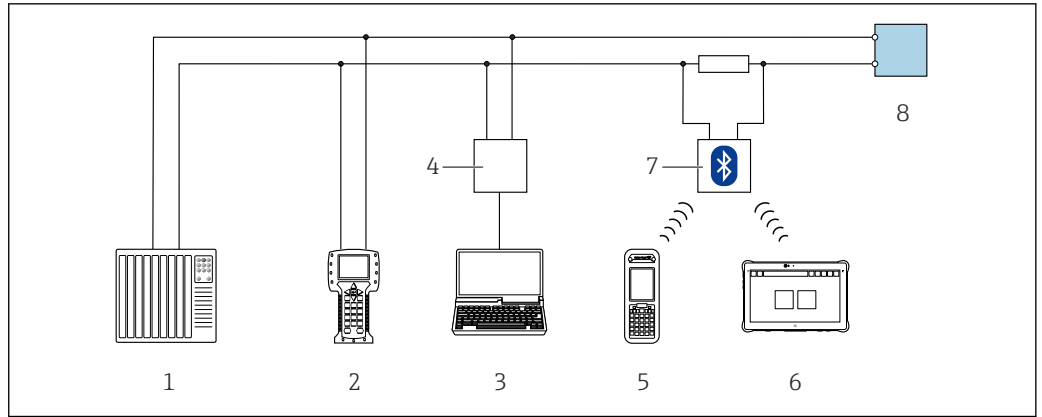

A0028747

52 Options for remote operation via HART protocol (active)

- 1 Control system (e.g. PLC)
- 2 Field Communicator 475
- 3 Computer with Web browser (e.g. Internet Explorer) for accessing the integrated device Web server or computer with operating tool (e.g. FieldCare, DeviceCare, AMS Device Manager, SIMATIC PDM) with COM DTM "CDI Communication TCP/IP"
- 4 Commubox FXA195 (USB)
- 5 Field Xpert SFX350 or SFX370
- 6 Field Xpert SMT70
- 7 VIATOR Bluetooth modem with connecting cable
- 8 Transmitter

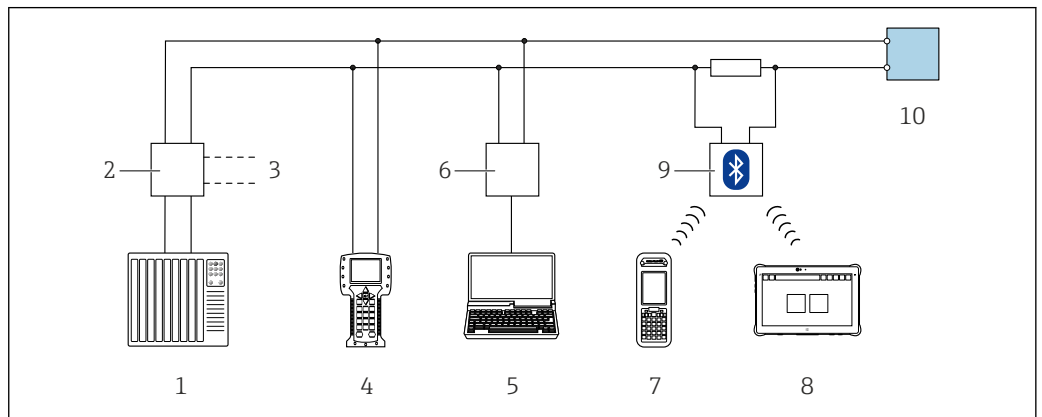

A0028746

53 Options for remote operation via HART protocol (passive)

- 1 Control system (e.g. PLC)
- 2 Transmitter power supply unit, e.g. RN221N (with communication resistor)
- 3 Connection for Commubox FXA195 and Field Communicator 475
- 4 Field Communicator 475
- 5 Computer with Web browser (e.g. Internet Explorer) for accessing the integrated device Web server or computer with operating tool (e.g. FieldCare, DeviceCare, AMS Device Manager, SIMATIC PDM) with COM DTM "CDI Communication TCP/IP"
- 6 Commubox FXA195 (USB)
- 7 Field Xpert SFX350 or SFX370
- 8 Field Xpert SMT70
- 9 VIATOR Bluetooth modem with connecting cable
- 10 Transmitter

**Via FOUNDATION Fieldbus network**

This communication interface is available in device versions with FOUNDATION Fieldbus.

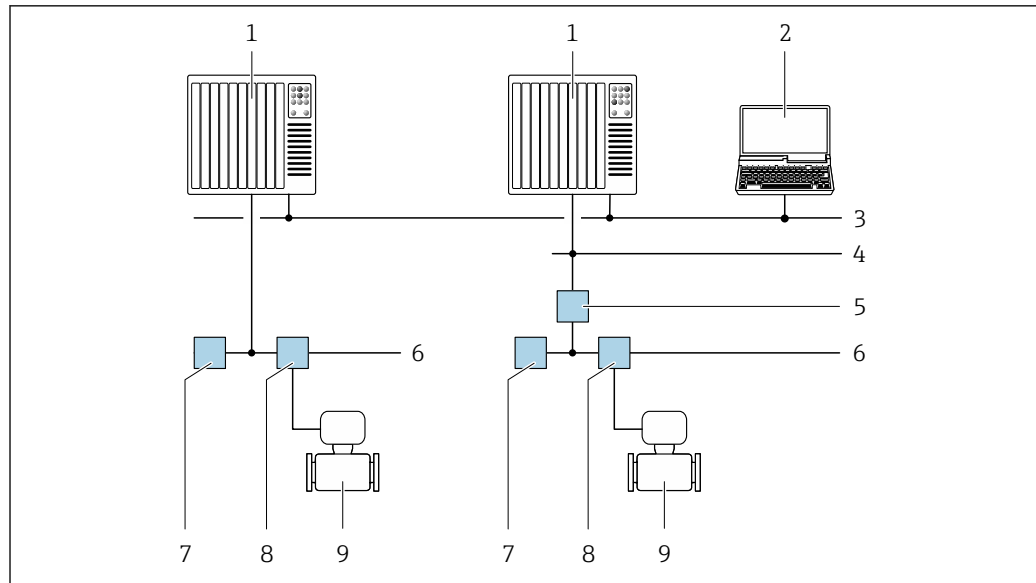

A0028837

54 Options for remote operation via FOUNDATION Fieldbus network

- 1 Automation system
- 2 Computer with FOUNDATION Fieldbus network card
- 3 Industry network
- 4 High Speed Ethernet FF-HSE network
- 5 Segment coupler FF-HSE/FF-H1
- 6 FOUNDATION Fieldbus FF-H1 network
- 7 Power supply FF-H1 network
- 8 T-box
- 9 Measuring device

#### Via PROFIBUS DP network

This communication interface is available in device versions with PROFIBUS DP.

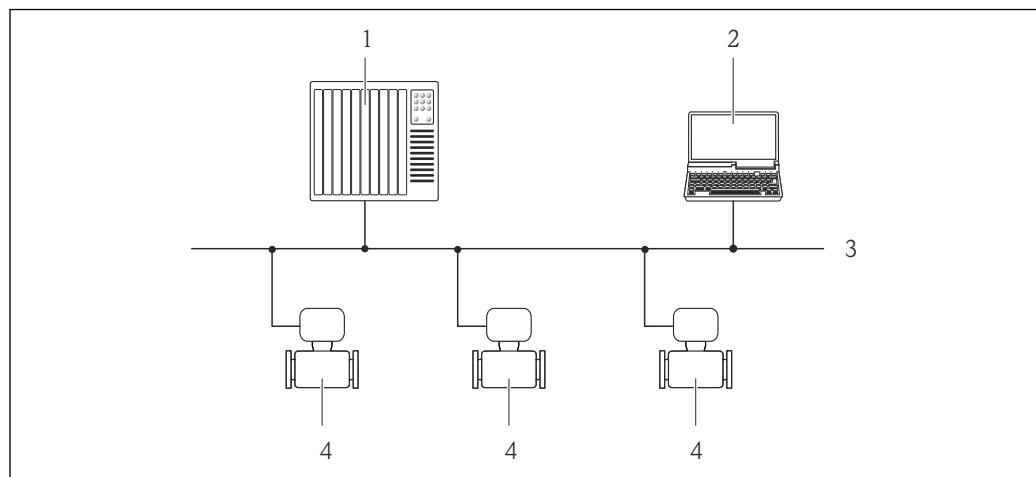

A0020903

55 Options for remote operation via PROFIBUS DP network

- 1 Automation system
- 2 Computer with PROFIBUS network card
- 3 PROFIBUS DP network
- 4 Measuring device

#### Via PROFIBUS PA network

This communication interface is available in device versions with PROFIBUS PA.

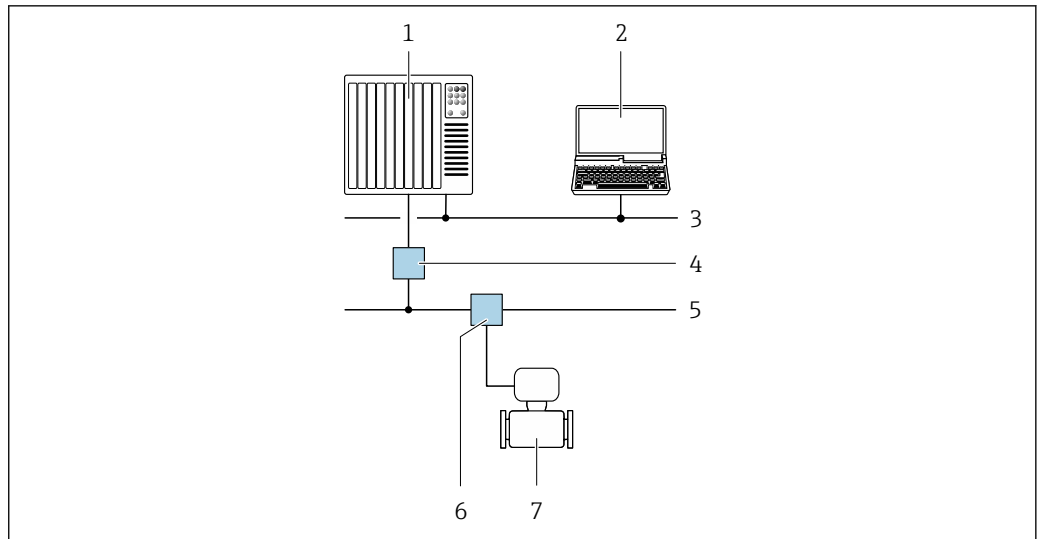

A0028838

56 Options for remote operation via PROFIBUS PA network

- 1 Automation system
- 2 Computer with PROFIBUS network card
- 3 PROFIBUS DP network
- 4 Segment coupler PROFIBUS DP/PA
- 5 PROFIBUS PA network
- 6 T-box
- 7 Measuring device

**Via Modbus RS485 protocol**

This communication interface is available in device versions with a Modbus-RS485 output.

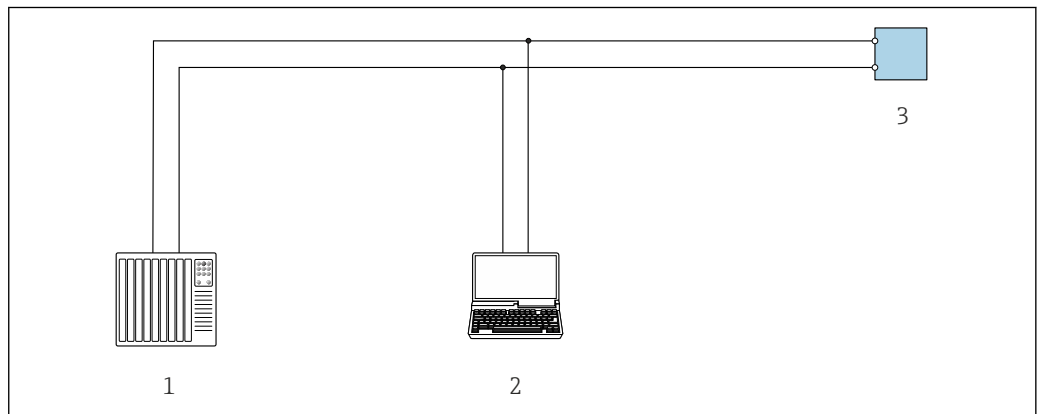

A0029437

57 Options for remote operation via Modbus-RS485 protocol (active)

- 1 Control system (e.g. PLC)
- 2 Computer with Web browser (e.g. Internet Explorer) for accessing the integrated device Web server or with operating tool (e.g. FieldCare, DeviceCare) with COM DTM "CDI Communication TCP/IP" or Modbus DTM
- 3 Transmitter

**Via EtherNet/IP network**

This communication interface is available in device versions with EtherNet/IP.

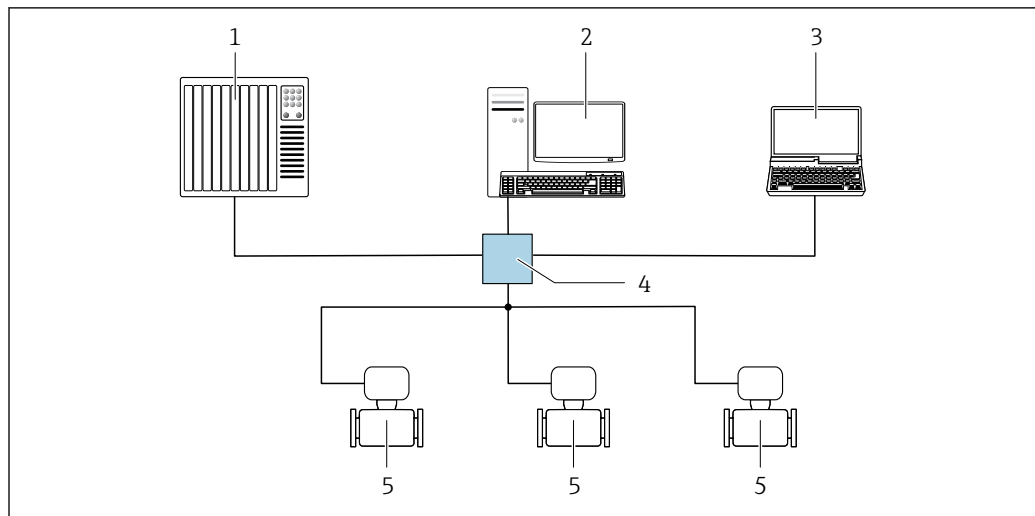
*Star topology*

A0032078

58 Options for remote operation via EtherNet/IP network: star topology

- 1 Automation system, e.g. "RSLogix" (Rockwell Automation)
- 2 Workstation for measuring device operation: with Custom Add-On Profile for "RSLogix 5000" (Rockwell Automation) or with Electronic Data Sheet (EDS)
- 3 Computer with Web browser (e.g. Internet Explorer) for accessing the integrated Web server or computer with operating tool (e.g. FieldCare, DeviceCare) with COM DTM "CDI Communication TCP/IP"
- 4 Standard Ethernet switch, e.g. Scalance X204 (Siemens)
- 5 Measuring device

*Ring topology*

The device is integrated via the terminal connection for signal transmission (output 1) and the service interface (CDI-RJ45).

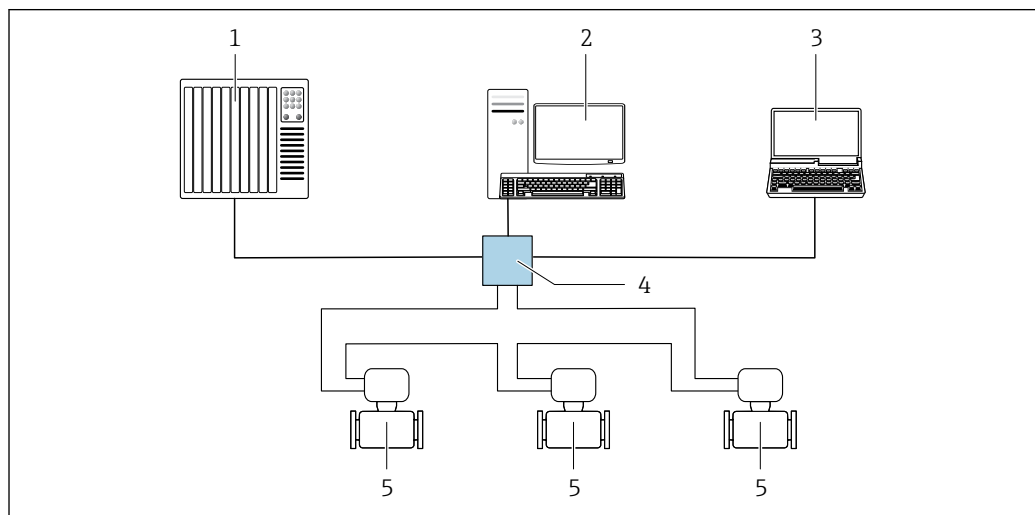

A0033725

59 Options for remote operation via EtherNet/IP network: ring topology

- 1 Automation system, e.g. "RSLogix" (Rockwell Automation)
- 2 Workstation for measuring device operation: with Custom Add-On Profile for "RSLogix 5000" (Rockwell Automation) or with Electronic Data Sheet (EDS)
- 3 Computer with Web browser (e.g. Internet Explorer) for accessing the integrated Web server or computer with operating tool (e.g. FieldCare, DeviceCare) with COM DTM "CDI Communication TCP/IP"
- 4 Standard Ethernet switch, e.g. Scalance X204 (Siemens)
- 5 Measuring device

**Via PROFINET network**

This communication interface is available in device versions with PROFINET.

Star topology

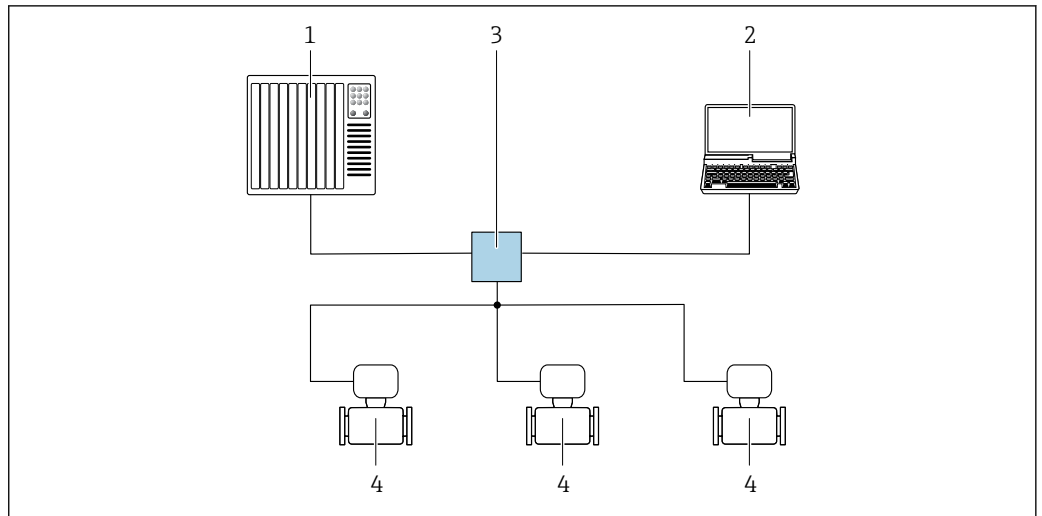

A0026545

60 Options for remote operation via PROFINET network: star topology

- 1 Automation system, e.g. Simatic S7 (Siemens)
- 2 Computer with Web browser (e.g. Internet Explorer) for accessing the integrated Web server or computer with operating tool (e.g. FieldCare, DeviceCare, SIMATIC PDM) with COM DTM "CDI Communication TCP/IP"
- 3 Standard Ethernet switch, e.g. Scalance X204 (Siemens)
- 4 Measuring device

Ring topology

The device is integrated via the terminal connection for signal transmission (output 1) and the service interface (CDI-RJ45).

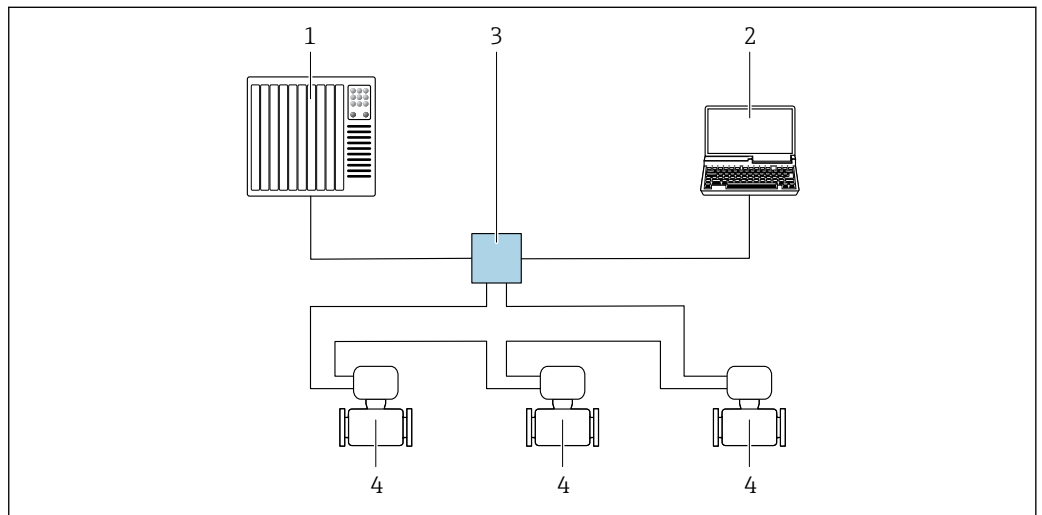

A0033719

61 Options for remote operation via PROFINET network: ring topology

- 1 Automation system, e.g. Simatic S7 (Siemens)
- 2 Computer with Web browser (e.g. Internet Explorer) for accessing the integrated Web server or computer with operating tool (e.g. FieldCare, DeviceCare, SIMATIC PDM) with COM DTM "CDI Communication TCP/IP"
- 3 Standard Ethernet switch, e.g. Scalance X204 (Siemens)
- 4 Measuring device

## Via APL network

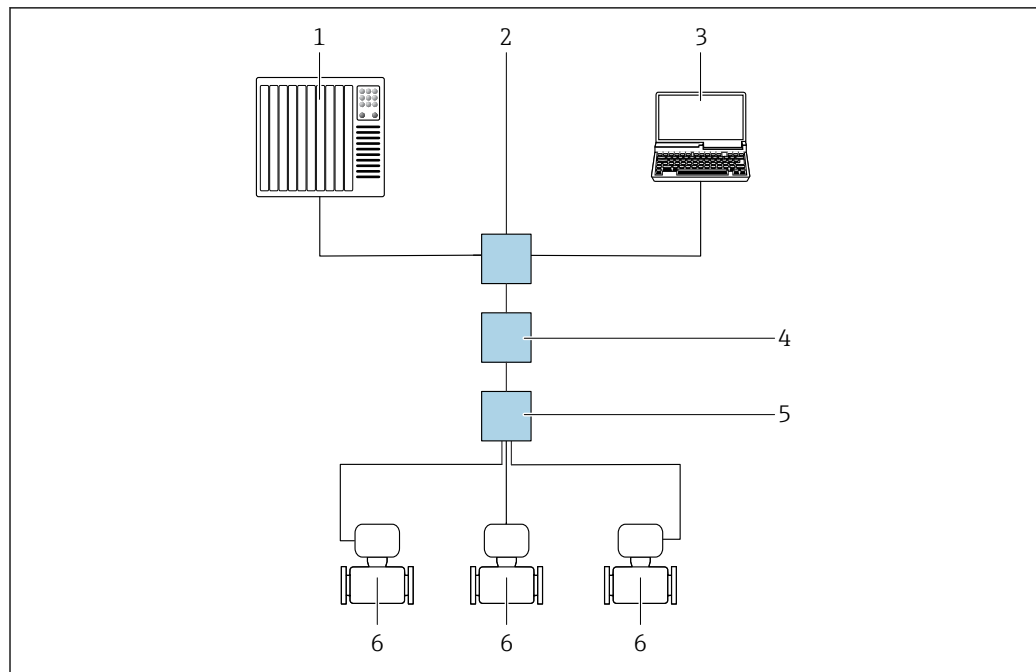

A0046117

 62 Options for remote operation via APL network

- 1 Automation system, e.g. Simatic S7 (Siemens)
- 2 Ethernet switch, e.g. Scalance X204 (Siemens)
- 3 Computer with Web browser (e.g. Internet Explorer) for access to integrated Web server or computer with operating tool (e.g. FieldCare or DeviceCare with PROFINET COM DTM or SIMATIC PDM with FDI-Package)
- 4 APL power switch (optional)
- 5 APL field switch
- 6 Measuring device

## Service interface

## Via service interface (CDI-RJ45)

A point-to-point connection can be established via onsite device configuration. With the housing open, the connection is established directly via the service interface (CDI-RJ45) of the device.

 An adapter for RJ45 to the M12 plug is optionally available:  
Order code for "Accessories", option **NB**: "Adapter RJ45 M12 (service interface)"

The adapter connects the service interface (CDI-RJ45) to an M12 plug mounted in the cable entry. The connection to the service interface can be established via an M12 plug without opening the device.

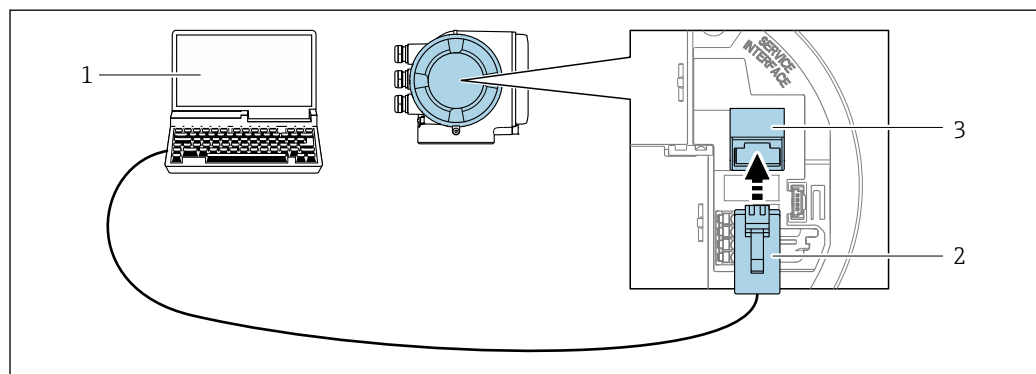

A0027563

 63 Connection via service interface (CDI-RJ45)

- 1 Computer with Web browser (e.g. Microsoft Internet Explorer, Microsoft Edge) for accessing the integrated Web server or with "FieldCare", "DeviceCare" operating tool with COM DTM "CDI Communication TCP/IP" or Modbus DTM
- 2 Standard Ethernet connecting cable with RJ45 plug
- 3 Service interface (CDI-RJ45) of the measuring device with access to the integrated Web server



**Via WLAN interface**

The optional WLAN interface is available on the following device version:  
 Order code for "Display; operation", option G "4-line, illuminated; touch control + WLAN"

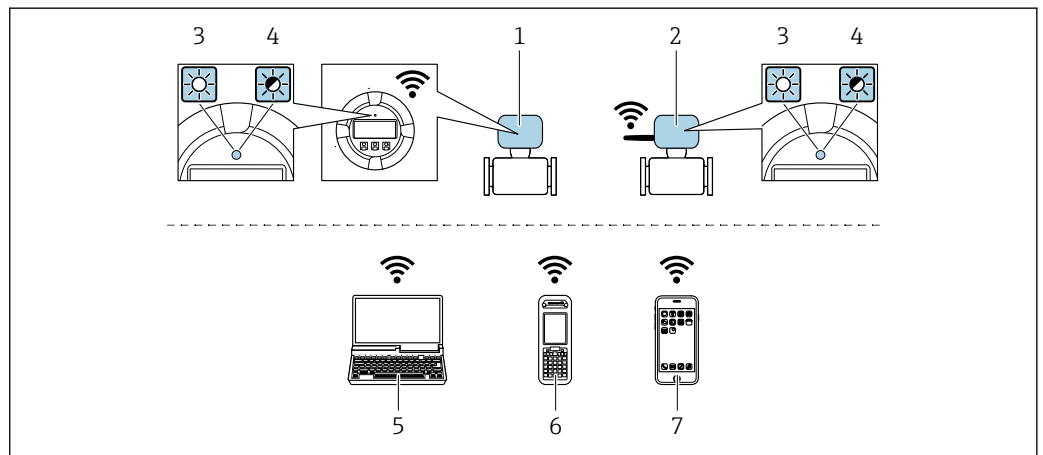

A0034570

- 1 Transmitter with integrated WLAN antenna
- 2 Transmitter with external WLAN antenna
- 3 LED lit constantly: WLAN reception is enabled on measuring device
- 4 LED flashing: WLAN connection established between operating unit and measuring device
- 5 Computer with WLAN interface and Web browser (e.g. Microsoft Internet Explorer, Microsoft Edge) for accessing the integrated device Web server or with operating tool (e.g. FieldCare, DeviceCare)
- 6 Mobile handheld terminal with WLAN interface and Web browser (e.g. Microsoft Internet Explorer, Microsoft Edge) for accessing the integrated device Web server or operating tool (e.g. FieldCare, DeviceCare)
- 7 Smart phone or tablet (e.g. Field Xpert SMT70)

Function	WLAN: IEEE 802.11 b/g (2.4 GHz) <ul style="list-style-type: none"> <li>▪ Access Point with DHCP server (factory setting)</li> <li>▪ Network</li> </ul>
Encryption	WPA2-PSK AES-128 (in accordance with IEEE 802.11i)
Configurable WLAN channels	1 to 11
Degree of protection	IP67
Available antennas	<ul style="list-style-type: none"> <li>▪ Internal antenna</li> <li>▪ External antenna (optional)                      In the event of poor transmission/reception conditions at the place of installation.                      Available as an accessory .</li> </ul> <p><b>i</b> Only 1 antenna is active at any one time!</p>
Range	<ul style="list-style-type: none"> <li>▪ Internal antenna: typically 10 m (32 ft)</li> <li>▪ External antenna: typically 50 m (164 ft)</li> </ul>
Materials (external antenna)	<ul style="list-style-type: none"> <li>▪ Antenna: ASA plastic (acrylic ester-styrene-acrylonitrile) and nickel-plated brass</li> <li>▪ Adapter: Stainless steel and nickel-plated brass</li> <li>▪ Cable: Polyethylene</li> <li>▪ Plug: Nickel-plated brass</li> <li>▪ Angle bracket: Stainless steel</li> </ul>

**Network integration**

**i** Network integration is only available for the HART communication protocol.

With the optional "OPC-UA Server" application package, the device can be integrated into an Ethernet network via the service interface (CDI-RJ45 and WLAN) and communicate with OPC-UA clients. If the device is used in this way, IT security must be considered.

**i** Transmitters with an Ex de approval may **not** be connected via the service interface (CDI-RJ45)!  
 Order code for "Approval transmitter + sensor", options (Ex de):  
 BA, BB, C1, C2, GA, GB, MA, MB, NA, NB

For permanent access to device data and for device configuration via the Web server, the device is incorporated directly in a network via the service interface (CDI-RJ45). In this way, the device can be accessed any time from the control station. The measured values are processed separately via the inputs and outputs through the automation system.

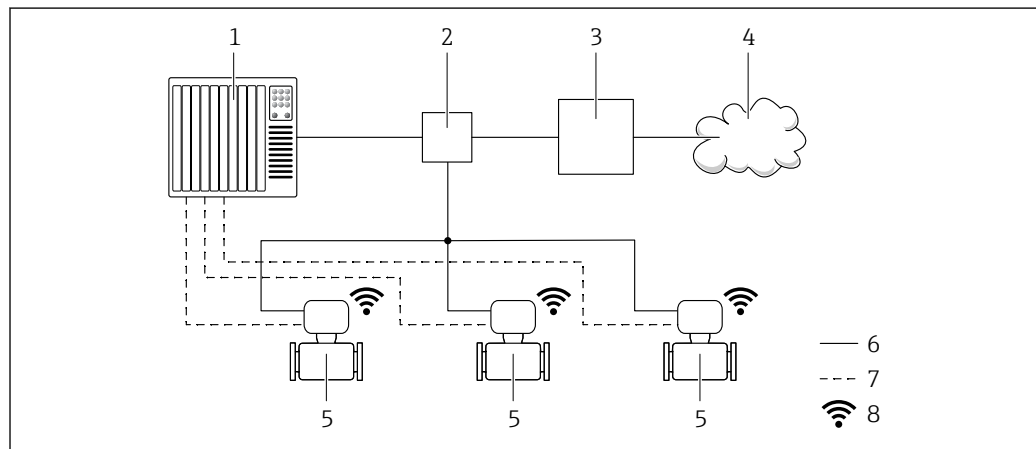

A0033618

- 1 Automation system, e.g. Simatic S7 (Siemens)
- 2 Ethernet switch
- 3 Edge Gateway
- 4 Cloud
- 5 Measuring device
- 6 Ethernet network
- 7 Measured values via inputs and outputs
- 8 Optional WLAN interface



The optional WLAN interface is available on the following device version:

Order code for "Display; operation", option **G** "4-line, backlit, graphic display; touch control + WLAN"



Special Documentation for the OPC-UA Server application package → 132.

## Supported operating tools

Different operating tools can be used for local or remote access to the measuring device. Depending on the operating tool used, access is possible with different operating units and via a variety of interfaces.

Supported operating tools	Operating unit	Interface	Additional information
Web browser	Notebook, PC or tablet with Web browser	<ul style="list-style-type: none"> <li>■ CDI-RJ45 service interface</li> <li>■ WLAN interface</li> <li>■ Ethernet-based fieldbus (EtherNet/IP, PROFINET)</li> </ul>	Special Documentation for the device → 132
DeviceCare SFE100	Notebook, PC or tablet with Microsoft Windows system	<ul style="list-style-type: none"> <li>■ CDI-RJ45 service interface</li> <li>■ WLAN interface</li> <li>■ Fieldbus protocol</li> </ul>	→ 130
FieldCare SFE500	Notebook, PC or tablet with Microsoft Windows system	<ul style="list-style-type: none"> <li>■ CDI-RJ45 service interface</li> <li>■ WLAN interface</li> <li>■ Fieldbus protocol</li> </ul>	→ 130

Supported operating tools	Operating unit	Interface	Additional information
Field Xpert	SMT70/77/50	<ul style="list-style-type: none"> <li>■ All fieldbus protocols</li> <li>■ WLAN interface</li> <li>■ Bluetooth</li> <li>■ CDI-RJ45 service interface</li> </ul>	Operating Instructions BA01202S  Device description files: Use update function of handheld terminal
SmartBlue app	Smart phone or tablet with iOS or Android	WLAN	→  130



Other operating tools based on FDT technology with a device driver such as DTM/iDTM or DD/EDD can be used for device operation. These operating tools are available from the individual manufacturers. Integration into the following operating tools, among others, is supported:

- FactoryTalk AssetCentre (FTAC) from Rockwell Automation → [www.rockwellautomation.com](http://www.rockwellautomation.com)
- Process Device Manager (PDM) from Siemens → [www.siemens.com](http://www.siemens.com)
- Asset Management Solutions (AMS) from Emerson → [www.emersonprocess.com](http://www.emersonprocess.com)
- FieldCommunicator 375/475 from Emerson → [www.emersonprocess.com](http://www.emersonprocess.com)
- Field Device Manager (FDM) from Honeywell → [www.process.honeywell.com](http://www.process.honeywell.com)
- FieldMate from Yokogawa → [www.yokogawa.com](http://www.yokogawa.com)
- PACTWare → [www.pactware.com](http://www.pactware.com)

The related device description files are available: [www.endress.com](http://www.endress.com) → Downloads

### Web server

Thanks to the integrated Web server the device can be operated and configured via a Web browser and via the service interface (CDI-RJ45) or via the WLAN interface. The structure of the operating menu is the same as for the local display. In addition to the measured values, device status information is also displayed and allows users to monitor the status of the device. Furthermore the device data can be managed and the network parameters can be configured.

A device that has a WLAN interface (can be ordered as an option) is required for the WLAN connection: order code for "Display; operation", option G "4-line, illuminated; touch control + WLAN". The device acts as an Access Point and enables communication by computer or a mobile handheld terminal.

### Supported functions

Data exchange between the operating unit (such as a notebook for example) and the measuring device:

- Upload the configuration from the measuring device (XML format, configuration backup)
- Save the configuration to the measuring device (XML format, restore configuration)
- Export event list (.csv file)
- Export parameter settings (.csv file or PDF file, document the measuring point configuration)
- Export the Heartbeat verification log (PDF file, only available with the "Heartbeat Verification" application package)
- Flash firmware version for device firmware upgrade, for instance
- Download driver for system integration
- Visualize up to 1000 saved measured values (only available with the **Extended HistoROM** application package →  126)



Web server special documentation →  132

### HistoROM data management

The measuring device features HistoROM data management. HistoROM data management comprises both the storage and import/export of key device and process data, making operation and servicing far more reliable, secure and efficient.



When the device is delivered, the factory settings of the configuration data are stored as a backup in the device memory. This memory can be overwritten with an updated data record, for example after commissioning.

### Additional information on the data storage concept

There are different types of data storage units in which device data are stored and used by the device:

	HistoROM backup	T-DAT	S-DAT
<b>Available data</b>	<ul style="list-style-type: none"> <li>▪ Event logbook such as diagnostic events for example</li> <li>▪ Parameter data record backup</li> <li>▪ Device firmware package</li> <li>▪ Driver for system integration for exporting via Web server, e.g.:               <ul style="list-style-type: none"> <li>▪ GSD for PROFIBUS DP</li> <li>▪ GSD for PROFIBUS PA</li> <li>▪ GSDML for PROFINET</li> <li>▪ EDS for EtherNet/IP</li> <li>▪ DD for FOUNDATION Fieldbus</li> </ul> </li> </ul>	<ul style="list-style-type: none"> <li>▪ Measured value logging ("Extended HistoROM" order option)</li> <li>▪ Current parameter data record (used by firmware at run time)</li> <li>▪ Maximum indicators (min/max values)</li> <li>▪ Totalizer values</li> </ul>	<ul style="list-style-type: none"> <li>▪ Sensor data: nominal diameter etc.</li> <li>▪ Serial number</li> <li>▪ Calibration data</li> <li>▪ Device configuration (e.g. SW options, fixed I/O or multi I/O)</li> </ul>
<b>Storage location</b>	Fixed on the user interface board in the connection compartment	Attachable to the user interface board in the connection compartment	In the sensor plug in the transmitter neck part

### Data backup

#### Automatic

- The most important device data (sensor and transmitter) are automatically saved in the DAT modules
- If the transmitter or measuring device is replaced: once the T-DAT containing the previous device data has been exchanged, the new measuring device is ready for operation again immediately without any errors
- If the sensor is replaced: once the sensor has been replaced, new sensor data are transferred from the S-DAT in the measuring device and the measuring device is ready for operation again immediately without any errors
- If exchanging the electronics module (e.g. I/O electronics module): Once the electronics module has been replaced, the software of the module is compared against the current device firmware. The module software is upgraded or downgraded where necessary. The electronics module is available for use immediately afterwards and no compatibility problems occur.

#### Manual

Additional parameter data record (complete parameter settings) in the integrated device memory HistoROM backup for:

- Data backup function  
Backup and subsequent restoration of a device configuration in the device memory HistoROM backup
- Data comparison function  
Comparison of the current device configuration with the device configuration saved in the device memory HistoROM backup

### Data transmission

#### Manual

- Transfer of a device configuration to another device using the export function of the specific operating tool, e.g. with FieldCare, DeviceCare or Web server: to duplicate the configuration or to store in an archive (e.g. for backup purposes)
- Transmission of the drivers for system integration via Web server, e.g.:
  - GSD for PROFIBUS DP
  - GSD for PROFIBUS PA
  - GSDML for PROFINET
  - EDS for EtherNet/IP
  - DD for FOUNDATION Fieldbus

**Event list****Automatic**

- Chronological display of up to 20 event messages in the events list
- If the **Extended HistoROM** application package (order option) is enabled: up to 100 event messages are displayed in the events list along with a time stamp, plain text description and remedial measures
- The events list can be exported and displayed via a variety of interfaces and operating tools e.g. DeviceCare, FieldCare or Web server

**Data logging****Manual**

If the **Extended HistoROM** application package (order option) is enabled:

- Record up to 1 000 measured values via 1 to 4 channels
- User configurable recording interval
- Record up to 250 measured values via each of the 4 memory channels
- Export the measured value log via a variety of interfaces and operating tools e.g. FieldCare, DeviceCare or web server

## Certificates and approvals

Current certificates and approvals that are available for the product can be selected via the Product Configurator at [www.endress.com](http://www.endress.com):

1. Select the product using the filters and search field.
2. Open the product page.
3. Select **Configuration**.

**CE mark**

The device meets the legal requirements of the applicable EU Directives. These are listed in the corresponding EU Declaration of Conformity along with the standards applied.

Endress+Hauser confirms successful testing of the device by affixing to it the CE mark.

**UKCA marking**

The device meets the legal requirements of the applicable UK regulations (Statutory Instruments). These are listed in the UKCA Declaration of Conformity along with the designated standards. By selecting the order option for UKCA marking, Endress+Hauser confirms a successful evaluation and testing of the device by affixing the UKCA mark.

Contact address Endress+Hauser UK:

Endress+Hauser Ltd.  
Floats Road  
Manchester M23 9NF  
United Kingdom  
[www.uk.endress.com](http://www.uk.endress.com)

**RCM mark**

The measuring system meets the EMC requirements of the "Australian Communications and Media Authority (ACMA)".

**Ex approval**

The measuring device is certified for use in hazardous areas and the relevant safety instructions are provided in the separate "Safety Instructions" (XA) document. Reference is made to this document on the nameplate.

Devices with the order code for "Approval; transmitter + sensor", option BA, BB, BC or BD have equipment protection level (EPL) Ga/Gb (Zone 0 in the measuring tube).

 The separate Ex documentation (XA) containing all the relevant explosion protection data is available from your Endress+Hauser sales center.

**ATEX/IECEx**

Currently, the following versions for use in hazardous areas are available:

*Ex db eb*

Category	Type of protection
II1/2G	Ex db eb ia IIC T6...T1 Ga/Gb Ex db eb ia IIB T6...T1 Ga/Gb
II2G	Ex db eb ia IIC T6...T1 Gb Ex db eb ia IIB T6...T1 Gb

*Ex db*

Category	Type of protection
II1/2G	Ex db ia IIC T6...T1 Ga/Gb Ex db ia IIB T6...T1 Ga/Gb
II2G	Ex db ia IIC T6...T1 Gb Ex db ia IIB T6...T1 Gb

*Ex ec*

Category	Type of protection
II3G	Ex ec IIC T5...T1 Gc

*Ex tb*

Category	Type of protection
II2D	Ex tb IIIC T** °C Db

**cCSA<sub>US</sub>**

Currently, the following versions for use in hazardous areas are available:

**IS (Ex i) and XP (Ex d)**

- Class I, II, III Division 1 Groups A-G
- Class I, II, III Division 1 Groups C-G

**NI (Ex ec)**

Class I Division 2 Groups A - D

**Ex db eb**

- Class I, Zone 1 AEx/ Ex db eb ia IIC T6...T1 Ga/Gb  
Class I, Zone 1 AEx/ Ex db eb ia IIB T6...T1 Ga/Gb
- Class I, Zone 1 AEx/Ex db eb ia IIC T6...T1 Gb  
Class I, Zone 1 AEx/Ex db eb ia IIB T6...T1 Gb

**Ex db**

- Class I, Zone 1 AEx/ Ex db ia IIC T6...T1 Ga/Gb  
Class I, Zone 1 AEx/ Ex db ia IIB T6...T1 Ga/Gb
- Class I, Zone 1 AEx/ Ex db ia IIC T6...T1 Gb  
Class I, Zone 1 AEx/ Ex db ia IIB T6...T1 Gb

**Ex ec**

Class I, Zone 2 AEx/ Ex ec IIC T5...T1 Gc

**Ex tb**

Zone 21 AEx/ Ex tb IIIC T\*\* °C Db

**Hygienic compatibility**

- 3-A approval
  - Only measuring devices with the order code for "Additional approval", option LP "3A" have 3-A approval.
  - The 3-A approval refers to the measuring device.
  - When installing the measuring device, ensure that no liquid can accumulate on the outside of the measuring device.  
A remote display module must be installed in accordance with the 3-A Standard.
  - Accessories (e.g. heating jacket, weather protection cover, wall holder unit) must be installed in accordance with the 3-A Standard.  
Each accessory can be cleaned. Disassembly may be necessary under certain circumstances.
- EHEDG-tested  
Only devices with the order code for "Additional approval", option LT "EHEDG" have been tested and meet the requirements of the EHEDG.  
To meet the requirements for EHEDG certification, the device must be used with process connections in accordance with the EHEDG position paper entitled "Easy cleanable Pipe couplings and Process connections" ([www.ehedg.org](http://www.ehedg.org)).
- FDA
- Food Contact Materials Regulation (EC) 1935/2004

**Pharmaceutical compatibility**



- FDA 21 CFR 177
- USP <87>
- USP <88> Class VI 121 °C
- TSE/BSE Certificate of Suitability
- cGMP  
Devices with the order code for "Test, certificate", option JG "Conformity with cGMP-derived requirements, declaration" comply with the requirements of cGMP with regard to the surfaces of parts in contact with the medium, design, FDA 21 CFR material conformity, USP Class VI tests and TSE/BSE conformity.  
A serial number-specific declaration is generated.

**Functional safety**

The measuring device can be used for flow monitoring systems (min., max., range) up to SIL 2 (single-channel architecture; order code for "Additional approval", option LA) and SIL 3 (multi-channel architecture with homogeneous redundancy) and is independently evaluated and certified in accordance with IEC 61508.

The following types of monitoring in safety equipment are possible:

- Mass flow
- Volume flow
- Density

 Functional Safety Manual with information on the SIL device →  132

**HART certification**

**HART interface**

The measuring device is certified and registered by the FieldComm Group. The measuring system meets all the requirements of the following specifications:

- Certified according to HART 7
- The device can also be operated with certified devices of other manufacturers (interoperability)

**FOUNDATION Fieldbus certification**

**FOUNDATION Fieldbus interface**

The measuring device is certified and registered by the FieldComm Group. The measuring system meets all the requirements of the following specifications:



- Certified in accordance with FOUNDATION Fieldbus H1
- Interoperability Test Kit (ITK), revision version 6.2.0 (certificate available on request)
- Physical Layer Conformance Test
- The device can also be operated with certified devices of other manufacturers (interoperability)

**Certification PROFIBUS**

**PROFIBUS interface**

The measuring device is certified and registered by the PNO (PROFIBUS Nutzerorganisation e.V./ PROFIBUS User Organization). The measuring system meets all the requirements of the following specifications:

- Certified according to PA Profile 3.02
- The device can also be operated with certified devices of other manufacturers (interoperability)

<b>EtherNet/IP certification</b>	<p>The measuring device is certified and registered by the ODVA (Open Device Vendor Association). The measuring system meets all the requirements of the following specifications:</p> <ul style="list-style-type: none"> <li>▪ Certified in accordance with the ODVA Conformance Test</li> <li>▪ EtherNet/IP Performance Test</li> <li>▪ EtherNet/IP PlugFest compliance</li> <li>▪ The device can also be operated with certified devices of other manufacturers (interoperability)</li> </ul>
<b>Certification PROFINET</b>	<p><b>PROFINET interface</b></p> <p>The measuring device is certified and registered by the PNO (PROFIBUS Nutzerorganisation e.V. / PROFIBUS User Organization). The measuring system meets all the requirements of the following specifications:</p> <ul style="list-style-type: none"> <li>▪ Certified according to: <ul style="list-style-type: none"> <li>▪ Test specification for PROFINET devices</li> <li>▪ PROFINET Security Level 2– Netload Class 2 0 Mbps</li> </ul> </li> <li>▪ The device can also be operated with certified devices of other manufacturers (interoperability)</li> <li>▪ The device supports PROFINET S2 system redundancy.</li> </ul>
<b>Certification PROFINET with Ethernet-APL</b>	<p><b>PROFINET interface</b></p> <p>The measuring device is certified and registered by the PNO (PROFIBUS Nutzerorganisation e.V. / PROFIBUS User Organization). The measuring system meets all the requirements of the following specifications:</p> <ul style="list-style-type: none"> <li>▪ Certified according to: <ul style="list-style-type: none"> <li>▪ Test specification for PROFINET devices</li> <li>▪ PROFINET PA Profile 4</li> <li>▪ PROFINET Security Level 2– Netload Class 2 0 Mbps</li> <li>▪ APL conformance test</li> </ul> </li> <li>▪ The device can also be operated with certified devices of other manufacturers (interoperability)</li> <li>▪ The device supports PROFINET S2 system redundancy.</li> </ul>
<b>Pressure Equipment Directive</b>	<p>The devices can be ordered with or without a PED or UKCA approval. If a device with a PED or UKCA approval is required, this must be explicitly stated in the order. For devices with nominal diameters less than or equal to DN 25 (1"), this is neither possible nor necessary. A UK Ex approval must be selected for UKCA.</p> <ul style="list-style-type: none"> <li>▪ With the marking: <ol style="list-style-type: none"> <li>a) PED/G1/x (x = category) or</li> <li>b) UK/G1/x (x = category)</li> </ol> <p>on the sensor nameplate, Endress+Hauser confirms compliance with the "Essential Safety Requirements"</p> <ol style="list-style-type: none"> <li>a) specified in Annex I of the Pressure Equipment Directive 2014/68/EU or</li> <li>b) Schedule 2 of Statutory Instruments 2016 No. 1105.</li> </ol> </li> <li>▪ Devices bearing this marking (PED or UKCA) are suitable for the following types of medium: <ul style="list-style-type: none"> <li>▪ Media in Group 1 and 2 with a vapor pressure greater than, or smaller and equal to 0.5 bar (7.3 psi)</li> <li>▪ Unstable gases</li> </ul> </li> <li>▪ Devices not bearing this marking (without PED or UKCA) are designed and manufactured according to sound engineering practice. They meet the requirements of <ol style="list-style-type: none"> <li>a) Art. 4 Para. 3 of the Pressure Equipment Directive 2014/68/EU or</li> <li>b) Part 1, Para. 8 of Statutory Instruments 2016 No. 1105.</li> </ol> <p>The scope of application is indicated</p> <ol style="list-style-type: none"> <li>a) in diagrams 6 to 9 in Annex II of the Pressure Equipment Directive 2014/68/EU or</li> <li>b) Schedule 3, Para. 2 of Statutory Instruments 2016 No. 1105.</li> </ol> </li> </ul>
<b>Radio approval</b>	<p>The measuring device has radio approval.</p> <p> For detailed information on the radio approval, see the Special Documentation →  132</p>
<b>Measuring instrument approval</b>	<p>The measuring device is (optionally) approved as a gas meter (MI-002) or component in measuring systems (MI-005) in service subject to legal metrological control in accordance with the European Measuring Instruments Directive 2014/32/EU (MID).</p> <p>The measuring device is qualified to OIML R117 or OIML R137 OIML R117 and has an OIML Certificate of Conformity (optional).</p>



**Additional certification**

**CRN approval**

Some device versions have CRN approval. A CRN-approved process connection with a CSA approval must be ordered for a CRN-approved device.

**Tests and certificates**

- EN10204-3.1 material certificate, wetted parts and sensor housing
- Pressure test, internal process, inspection certificate
- PMI test (XRF), internal procedure, wetted parts, test report
- Compliance with requirements derived from cGMP, Declaration
- EN10204-2.1 confirmation of compliance with the order and EN10204-2.2 test report

*Testing of welded connections*

Option	Test standard				Component	
	ISO 23277 AL2x (PT) ISO 10675-1 AL1 (RT, DR)	ASME B31.3 NFS	ASME VIII Div.1 Appx. 4+8	NORSOK M-601	Measuring tube	Process connection
KF	x				PT	RT
KK		x			PT	RT
KP			x		PT	RT
KR				x	VT, PT	VT, RT
K1	x				PT	DR
K2		x			PT	DR
K3			x		PT	DR
K4				x	VT, PT	VT, DR
PT = penetrant testing, RT = radiographic testing, VT = visual testing, DR = digital radiography All options with test report						

**Other standards and guidelines**

- EN 60529  
Degrees of protection provided by enclosures (IP code)
- IEC/EN 60068-2-6  
Environmental influences: Test procedure - Test Fc: vibrate (sinusoidal).
- IEC/EN 60068-2-31  
Environmental influences: Test procedure - Test Ec: shocks due to rough handling, primarily for devices.
- EN 61010-1  
Safety requirements for electrical equipment for measurement, control and laboratory use - general requirements
- IEC/EN 61326-2-3  
Emission in accordance with Class A requirements. Electromagnetic compatibility (EMC requirements).
- NAMUR NE 21  
Electromagnetic compatibility (EMC) of industrial process and laboratory control equipment
- NAMUR NE 32  
Data retention in the event of a power failure in field and control instruments with microprocessors
- NAMUR NE 43  
Standardization of the signal level for the breakdown information of digital transmitters with analog output signal.
- NAMUR NE 53  
Software of field devices and signal-processing devices with digital electronics
- NAMUR NE 80  
The application of the pressure equipment directive to process control devices
- NAMUR NE 105  
Specifications for integrating fieldbus devices in engineering tools for field devices
- NAMUR NE 107  
Self-monitoring and diagnosis of field devices
- NAMUR NE 131  
Requirements for field devices for standard applications

- NAMUR NE 132  
Coriolis mass meter
- NACE MRO103  
Materials resistant to sulfide stress cracking in corrosive petroleum refining environments.
- NACE MRO175/ISO 15156-1  
Materials for use in H2S-containing Environments in Oil and Gas Production.
- ETSI EN 300 328  
Guidelines for 2.4 GHz radio components.
- EN 301489  
Electromagnetic compatibility and radio spectrum matters (ERM).

## Ordering information

Detailed ordering information is available from your nearest sales organization [www.addresses.endress.com](http://www.addresses.endress.com) or in the Product Configurator at [www.endress.com](http://www.endress.com):

1. Select the product using the filters and search field.
2. Open the product page.
3. Select **Configuration**.



### **Product Configurator - the tool for individual product configuration**

- Up-to-the-minute configuration data
- Depending on the device: Direct input of measuring point-specific information such as measuring range or operating language
- Automatic verification of exclusion criteria
- Automatic creation of the order code and its breakdown in PDF or Excel output format
- Ability to order directly in the Endress+Hauser Online Shop

## Application packages

Many different application packages are available to enhance the functionality of the device. Such packages might be needed to address safety aspects or specific application requirements.

The application packages can be ordered with the device or subsequently from Endress+Hauser. Detailed information on the order code in question is available from your local Endress+Hauser sales center or on the product page of the Endress+Hauser website: [www.endress.com](http://www.endress.com).

 Detailed information on the application packages:  
Special Documentation for the device →  132

### Diagnostic functionality

Order code for "Application package", option EA "Extended HistoROM"

Comprises extended functions concerning the event log and the activation of the measured value memory.

Event log:

Memory volume is extended from 20 message entries (standard version) to up to 100 entries.

Data logging (line recorder):

- Memory capacity for up to 1000 measured values is activated.
- 250 measured values can be output via each of the 4 memory channels. The recording interval can be defined and configured by the user.
- Measured value logs can be accessed via the local display or operating tool e.g. FieldCare, DeviceCare or Web server.

 For detailed information, see the Operating Instructions for the device.

### Heartbeat Technology

Order code for "Application package", option EB "Heartbeat Verification + Monitoring"

**Heartbeat Verification**

Meets the requirement for traceable verification to DIN ISO 9001:2008 Chapter 7.6 a) "Control of monitoring and measuring equipment".

- Functional testing in the installed state without interrupting the process.
- Traceable verification results on request, including a report.
- Simple testing process via local operation or other operating interfaces.
- Clear measuring point assessment (pass/fail) with high test coverage within the framework of manufacturer specifications.
- Extension of calibration intervals according to operator's risk assessment.

**Heartbeat Monitoring**

Continuously supplies data, which are characteristic of the measuring principle, to an external condition monitoring system for the purpose of preventive maintenance or process analysis. These data enable the operator to:

- Draw conclusions - using these data and other information - about the impact the process influences (e.g. corrosion, abrasion, formation of buildup etc.) have on measuring performance over time.
- Schedule servicing in time.
- Monitor the process or product quality, e.g. gas pockets.



For detailed information, see the Special Documentation for the device.

**Concentration measurement**

Order code for "Application package", option ED "Concentration"

Calculation and outputting of fluid concentrations.

The measured density is converted to the concentration of a substance of a binary mixture using the "Concentration" application package:

- Choice of predefined fluids (e.g. various sugar solutions, acids, alkalis, salts, ethanol etc.).
- Common or user-defined units ("Brix", "Plato", % mass, % volume, mol/l etc.) for standard applications.
- Concentration calculation from user-defined tables.



For detailed information, see the Special Documentation for the device.

**Special density**

Order code for "Application package", option EE "Special density"

Many applications use density as a key measured value for monitoring quality or controlling processes. The device measures the density of the fluid as standard and makes this value available to the control system.

The "Special Density" application package offers high-precision density measurement over a wide density and temperature range particularly for applications subject to varying process conditions.



For detailed information, see the Operating Instructions for the device.

**Petroleum**

Order code for "Application package", option EJ "Petroleum"

The most important parameters for the Oil & Gas Industry can be calculated and displayed with this application package.

- Corrected volume flow and calculated reference density in accordance with the "API Manual of Petroleum Measurement Standards, Chapter 11.1"
- Water content, based on density measurement
- Weighted mean of the density and temperature



For detailed information, see the Special Documentation for the device.

**Petroleum & locking function**

Order code for "Application package", option EM "Petroleum & locking function"

The most important parameters for the Oil & Gas Industry can be calculated and displayed with this application package. It is also possible to lock the settings.

- Corrected volume flow and calculated reference density in accordance with the "API Manual of Petroleum Measurement Standards, Chapter 11.1"
- Water content, based on density measurement
- Weighted mean of the density and temperature



For detailed information, see the Special Documentation for the device.

## OPC-UA Server

Order code for "Application package", option EL "OPC-UA Server"

The application package provides an integrated OPC-UA server for comprehensive device services for IoT and SCADA applications.



For detailed information, see the Special Documentation for the device.

## Accessories







Various accessories, which can be ordered with the device or subsequently from Endress+Hauser, are available for the device. Detailed information on the order code in question is available from your local Endress+Hauser sales center or on the product page of the Endress+Hauser website:

[www.endress.com](http://www.endress.com).



### Device-specific accessories

#### For the transmitter









Accessories	Description
Proline 300 transmitter	<p>Transmitter for replacement or storage. Use the order code to define the following specifications:</p> <ul style="list-style-type: none"> <li>▪ Approvals</li> <li>▪ Output</li> <li>▪ Input</li> <li>▪ Display/operation</li> <li>▪ Housing</li> <li>▪ Software</li> </ul> <p> Order code: 8X3BXX</p> <p> Installation Instructions EA01200D</p>
Remote display and operating module DKX001	<ul style="list-style-type: none"> <li>▪ If ordered directly with the measuring device: Order code for "Display; operation", option O "Remote display 4-line, illuminated; 10 m (30 ft) cable; touch control"</li> <li>▪ If ordered separately: <ul style="list-style-type: none"> <li>▪ Measuring device: order code for "Display; operation", option M "W/o, prepared for remote display"</li> <li>▪ DKX001: Via the separate product structure DKX001</li> </ul> </li> <li>▪ If ordered subsequently: DKX001: Via the separate product structure DKX001</li> </ul> <p><b>Mounting bracket for DKX001</b></p> <ul style="list-style-type: none"> <li>▪ If ordered directly: order code for "Accessory enclosed", option RA "Mounting bracket, pipe 1/2"</li> <li>▪ If ordered subsequently: order number: 71340960</li> </ul> <p><b>Connecting cable (replacement cable)</b> Via the separate product structure: DKX002</p> <p> Further information on display and operating module DKX001 →  110.</p> <p> Special Documentation SD01763D</p>







External WLAN antenna	<p>External WLAN antenna with 1.5 m (59.1 in) connecting cable and two angle brackets. Order code for "Accessory enclosed", option P8 "Wireless antenna wide area".</p> <ul style="list-style-type: none"> <li> The external WLAN antenna is not suitable for use in hygienic applications.</li> <li> Additional information regarding the WLAN interface →  117.</li> </ul> <p> Order number: 71351317</p> <p> Installation Instructions EA01238D</p>
Weather protection cover	<p>Is used to protect the measuring device from the effects of the weather: e.g. rainwater, excess heating from direct sunlight.</p> <p> Order number: 71343505</p> <p> Installation Instructions EA01160D</p>

**For the sensor**



Accessories	Description
Heating jacket	<p>Is used to stabilize the temperature of the fluids in the sensor. Water, water vapor and other non-corrosive liquids are permitted for use as fluids.</p> <ul style="list-style-type: none"> <li> If using oil as a heating medium, please consult with Endress+Hauser.</li> </ul> <p>Heating jackets cannot be used with sensors fitted with a rupture disk. Use the order code with the product root DK8003.</p> <p> Special Documentation SD02156D</p>

**Communication-specific accessories**





Accessories	Description
Commubox FXA195 HART	<p>For intrinsically safe HART communication with FieldCare via the USB interface.</p> <p> Technical Information TI00404F</p>
HART Loop Converter HMX50	<p>Is used to evaluate and convert dynamic HART process variables to analog current signals or limit values.</p> <ul style="list-style-type: none"> <li> Technical Information TI00429F</li> <li> Operating Instructions BA00371F</li> </ul>
Fieldgate FXA42	<p>Is used to transmit the measured values of connected 4 to 20 mA analog measuring devices, as well as digital measuring devices</p> <ul style="list-style-type: none"> <li> Technical Information TI01297S</li> <li> Operating Instructions BA01778S</li> <li> Product page: <a href="http://www.endress.com/fxa42">www.endress.com/fxa42</a></li> </ul>
Field Xpert SMT50	<p>The Field Xpert SMT70 tablet PC for device configuration enables mobile plant asset management in non-hazardous areas. It is suitable for commissioning and maintenance staff to manage field instruments with a digital communication interface and to record progress.</p> <p>This tablet PC is designed as an all-in-one solution with a preinstalled driver library and is an easy-to-use, touch-sensitive tool which can be used to manage field instruments throughout their entire life cycle.</p> <ul style="list-style-type: none"> <li> Technical Information TI01342S</li> <li> Operating Instructions BA01709S</li> <li> Product page: <a href="http://www.endress.com/smt50">www.endress.com/smt50</a></li> </ul>



Field Xpert SMT70	<p>The Field Xpert SMT70 tablet PC for device configuration enables mobile plant asset management in hazardous and non-hazardous areas. It is suitable for commissioning and maintenance staff to manage field instruments with a digital communication interface and to record progress.</p> <p>This tablet PC is designed as an all-in-one solution with a preinstalled driver library and is an easy-to-use, touch-sensitive tool which can be used to manage field instruments throughout their entire life cycle.</p> <ul style="list-style-type: none"> <li> Technical Information TI01342S</li> <li> Operating Instructions BA01709S</li> <li> Product page: <a href="http://www.endress.com/smt70">www.endress.com/smt70</a></li> </ul>
Field Xpert SMT77	<p>The Field Xpert SMT77 tablet PC for device configuration enables mobile plant asset management in areas categorized as Ex Zone 1.</p> <ul style="list-style-type: none"> <li> Technical Information TI01418S</li> <li> Operating Instructions BA01923S</li> <li> Product page: <a href="http://www.endress.com/smt77">www.endress.com/smt77</a></li> </ul>

## Service-specific accessories

Accessory	Description
Applicator	<p>Software for selecting and sizing Endress+Hauser measuring devices:</p> <ul style="list-style-type: none"> <li>▪ Choice of measuring devices with industrial requirements</li> <li>▪ Calculation of all the necessary data for identifying the optimum flowmeter: e.g. nominal diameter, pressure loss, flow velocity and accuracy.</li> <li>▪ Graphic illustration of the calculation results</li> <li>▪ Determination of the partial order code, administration, documentation and access to all project-related data and parameters over the entire life cycle of a project.</li> </ul> <p>Applicator is available:</p> <ul style="list-style-type: none"> <li>▪ Via the Internet: <a href="https://portal.endress.com/webapp/applicator">https://portal.endress.com/webapp/applicator</a></li> <li>▪ As a downloadable DVD for local PC installation.</li> </ul>
W@M	<p>W@M Life Cycle Management</p> <p>Improved productivity with information at your fingertips. Data relevant to a plant and its components is generated from the first stages of planning and during the asset's complete life cycle.</p> <p>W@M Life Cycle Management is an open and flexible information platform with online and on-site tools. Instant access for your staff to current, in-depth data shortens your plant's engineering time, speeds up procurement processes and increases plant uptime.</p> <p>Combined with the right services, W@M Life Cycle Management boosts productivity in every phase. For more information, see: <a href="http://www.endress.com/lifecyclemanagement">www.endress.com/lifecyclemanagement</a></p>
FieldCare	<p>FDT-based plant asset management tool from Endress+Hauser.</p> <p>It can configure all smart field units in your system and helps you manage them. By using the status information, it is also a simple but effective way of checking their status and condition.</p> <ul style="list-style-type: none"> <li> Operating Instructions BA00027S and BA00059S</li> </ul>
DeviceCare	<p>Tool for connecting and configuring Endress+Hauser field devices.</p> <ul style="list-style-type: none"> <li> Innovation brochure IN01047S</li> </ul>

## System components

Accessories	Description
Memograph M graphic data manager	<p>The Memograph M graphic data manager provides information on all the relevant measured variables. Measured values are recorded correctly, limit values are monitored and measuring points analyzed. The data are stored in the 256 MB internal memory and also on a SD card or USB stick.</p> <ul style="list-style-type: none"> <li> Technical Information TI00133R</li> <li> Operating Instructions BA00247R</li> </ul>
Cerabar M	<p>The pressure transmitter for measuring the absolute and gauge pressure of gases, steam and liquids. It can be used to read in the operating pressure value.</p> <ul style="list-style-type: none"> <li> Technical Information TI00426P and TI00436P</li> <li> Operating Instructions BA00200P and BA00382P</li> </ul>

Accessories	Description
Cerabar S	The pressure transmitter for measuring the absolute and gauge pressure of gases, steam and liquids. It can be used to read in the operating pressure value.  <ul style="list-style-type: none"> <li>▪ Technical Information TI00383P</li> <li>▪ Operating Instructions BA00271P</li> </ul>
iTEMP	The temperature transmitters can be used in all applications and are suitable for the measurement of gases, steam and liquids. They can be used to read in the medium temperature.  "Fields of Activity" document FA00006T

## Documentation

-  For an overview of the scope of the associated Technical Documentation, refer to the following:
- *Device Viewer* ([www.endress.com/deviceviewer](http://www.endress.com/deviceviewer)): Enter serial number from nameplate.
  - *Endress+Hauser Operations app*: Enter serial number from nameplate or scan matrix code on nameplate.

### Standard documentation      Brief Operating Instructions

*Brief Operating Instructions for the sensor*

Measuring device	Documentation code
Proline Promass F	KA01261D

*Brief Operating Instructions for the transmitter*

Measuring device	Documentation code							PROFINET with Ethernet-APL
	HART	FOUNDATION Fieldbus	PROFIBUS PA	PROFIBUS DP	Modbus RS485	EtherNet/IP	PROFINET	
Proline 300	KA01309D	KA01229D	KA01227D	KA01386D	KA01311D	KA01339D	KA01341D	KA01517D

### Operating Instructions

Measuring device	Documentation code							PROFINET with Ethernet-APL
	HART	FOUNDATION Fieldbus	PROFIBUS PA	PROFIBUS DP	Modbus RS485	EtherNet/IP	PROFINET	
Promass F 300	BA01485D	BA01518D	BA01507D	BA01850D	BA01496D	BA01728D	BA01739D	BA01739D

### Description of Device Parameters

Measuring device	Documentation code							PROFINET with Ethernet-APL
	HART	FOUNDATION Fieldbus	PROFIBUS PA	PROFIBUS DP	Modbus RS485	EtherNet/IP	PROFINET	
Promass 300	GP01057D	GP01094D	GP01058D	GP01134D	GP01059D	GP01114D	GP01115D	GP01168D

**Supplementary device-  
dependent documentation****Safety instructions**

Safety instructions for electrical equipment for hazardous areas.

Contents	Documentation code
ATEX/IECEX Ex d/Ex de	XA01405D
ATEX/IECEX Ex ec	XA01439D
cCSAus XP	XA01373D
cCSAus Ex d/ Ex de	XA01372D
cCSAus Ex nA	XA01507D
INMETRO Ex d/Ex de	XA01468D
INMETRO Ex ec	XA01470D
NEPSI Ex d/Ex de	XA01469D
NEPSI Ex nA	XA01471D
EAC Ex d/Ex de	XA01656D
EAC Ex nA	XA01657D
JPN Ex d	XA01778D

*Remote display and operating module DKX001*

Contents	Documentation code
ATEX/IECEX Ex i	XA01494D
ATEX/IECEX Ex ec	XA01498D
cCSAus IS	XA01499D
cCSAus Ex nA	XA01513D
INMETRO Ex i	XA01500D
INMETRO Ex ec	XA01501D
NEPSI Ex i	XA01502D
NEPSI Ex nA	XA01503D

**Functional Safety Manual**

Contents	Documentation code
Proline Promass 300	SD01727D

**Special Documentation**

Contents	Documentation code
Information on the Pressure Equipment Directive	SD01614D
Remote display and operating module DKX001	SD01763D
Radio approvals for WLAN interface for A309/A310 display module	SD01793D
OPC-UA server <sup>1)</sup>	SD02039D

1) This Special Documentation is only available for device versions with a HART output.



Contents	Documentation code							
	HART	FOUNDATION Fieldbus	PROFIBUS PA	PROFIBUS DP	Modbus RS485	PROFINET	EtherNet/IP	PROFINET with Ethernet-APL
Web server	SD01662D	SD01665D	SD01664D	SD02226D	SD01663D	SD01969D	SD01968D	SD02762D
Heartbeat Technology	SD01642D	SD01696D	SD01698D	SD02202D	SD01697D	SD01988D	SD01982	SD02731D
Concentration measurement	SD01644D	SD01706D	SD01708D	SD02212D	SD01707D	SD02005D	SD02004D	SD02735D
Petroleum	SD02097D	-	SD02291D	SD02216D	SD02098D	SD02099D	SD02096D	SD02739D
Petroleum & locking function	SD02499D	-	-	-	SD02500D	-	-	SD02739D
Gas Fraction Handler	SD02584D	-	-	-	SD02584D	SD02584D	-	SD02584D
Custody transfer	SD01688D	-	-	-	SD01689D	-	-	-

### Installation Instructions

Contents	Comment
Installation instructions for spare part sets and accessories	Documentation code: specified for each individual accessory → 128.

## Registered trademarks

### HART®

Registered trademark of the FieldComm Group, Austin, Texas, USA

### PROFIBUS®

Registered trademark of the PROFIBUS Nutzerorganisation e.V. (PROFIBUS User Organization), Karlsruhe, Germany

### FOUNDATION™ Fieldbus

Registration-pending trademark of the FieldComm Group, Austin, Texas, USA

### Modbus®

Registered trademark of SCHNEIDER AUTOMATION, INC.

### EtherNet/IP™

Trademark of ODVA, Inc.

### Ethernet-APL™

Registered trademark of the PROFIBUS Nutzerorganisation e.V. (PROFIBUS User Organization), Karlsruhe, Germany

### PROFINET®

Registered trademark of the PROFIBUS Nutzerorganisation e.V. (PROFIBUS User Organization), Karlsruhe, Germany

### TRI-CLAMP®

Registered trademark of Ladish & Co., Inc., Kenosha, USA



[www.addresses.endress.com](http://www.addresses.endress.com)

---